

Ultralow Noise Performance of an 8.4-GHz Maser–Feedhorn System

D. L. Johnson, S. M. Petty, J. J. Kovatch, and G. W. Glass
Radio Frequency and Microwave Subsystems Section

A total system noise temperature of 6.6 K has been demonstrated with an 8.4-GHz traveling wave maser and feedhorn operating in a cryogenic environment. Both the maser and feedhorn were inserted in the helium cryostat, with the maser operating in the 1.6-K liquid bath and the feedhorn cooled in the helium gas, with a temperature gradient along the horn ranging from the liquid bath temperature at its lower end to room temperature at its top. The ruby maser exhibited 43 dB of gain with a bandwidth of 76 MHz (–3 dB) centered at 8400 MHz. Discussions of the maser, cooled feedhorn, and cryostat designs are presented along with a discussion of the noise temperature measurements.

I. Introduction

The DSN currently uses low-noise maser amplifiers operating in 4.5-K closed-cycle refrigerators on the tipping structure of 70-m and 34-m Cassegrain antennas to receive microwave signals from deep space. A measure of the communications downlink performance for these antennas is the ratio of G/T , that is, the gain of the ground-based antenna divided by the system noise temperature. Improvements in G/T at a given frequency can be made by increasing the effective collecting area and efficiency of the antenna or lowering the system noise temperature.

The total system noise temperature of a typical 70-meter antenna with the 8450-MHz Block II-A maser operating in a receive-only mode is about 20 K at zenith on a clear, dry day. Of this 20 K, 4 K can be attributed to the antenna, 1.2 K to the dichroic plate, 6 K to the room-temperature feed components, and 3.8 K (nominal) to the maser, with the remaining noise temperature being attributed to the sky (cosmic background plus atmosphere). Thus, the room temperature feed components collectively are the largest single contributor to the antenna system noise temperature in the present X-band Deep Space Network (DSN) receiving systems.

New 34-m beam waveguide antennas are being implemented in the DSN that will provide, in contrast to present DSN antennas, a relatively large nontipping location for the maser and feed components. For these antennas, the use of a superfluid (below 2 K) liquid helium cryostat becomes very practical as a means to cool a maser and feed components, and achieve a very low system noise temperature. Operation of the maser near 1.6 K instead of 4.5 K dramatically improves its performance by both increasing its gain-bandwidth product and reducing its noise temperature from 3.8 K to about 1.0 K. The feedhorn and other feed components can be cooled as well, reducing their noise-temperature contributions to almost negligible levels. This reduction in noise temperature of the feed components and the maser can improve the total system-noise temperature by as much as 8.7 K and enable increased data rate capability for spacecraft missions such as Galileo.

This article describes a cryogenically cooled 8.4-GHz feedhorn and maser amplifier, enclosed in a 1.6-K superfluid helium dewar, that were developed and tested to demonstrate the above concept.

II. Description

The cryogenically cooled feedhorn-maser assembly described in this article is shown in Fig. 1. A block diagram of the microwave portion of the system is shown in Fig. 2. Major components include the dewar, feedhorn, waveguide directional input coupler, and the maser amplifier. The feedhorn-maser assembly is contained in a liquid-helium-filled dewar with the maser immersed in superfluid liquid helium and the feedhorn cooled by the discharging helium vapors. The 60-liter capacity dewar (International Cryogenics, Inc.) is 104-cm deep and has a 25.4-cm-diameter neck. The feedhorn (hereafter referred to as the horn) is attached by a flange at its aperture to the top plate of the dewar and suspended into the dewar. The maser is rigidly supported with stainless steel tubing attached to the lower end of the horn. A 7.6-cm-high, aluminum extension ring is set on top of the dewar to provide sufficient space under the horn aperture for microwave and electrical feedthroughs and for two helium vapor pumping ports. The maser output and pump waveguides are copper-plated, thin-walled stainless steel in the upper end of the dewar to maintain low radio frequency loss while minimizing heat leak to the helium bath. Mica waveguide windows and a Kapton¹ film horn aperture window were used to seal the dewar from the outside ambient air.

¹ Registered trademark of the DuPont Company.

The temperature of the liquid helium bath is reduced below 4.2 K by evacuating the helium vapors in the dewar. Helium vapor pumping is provided via two pumping ports at the top of the dewar connected to two helium-tight, single-stage Leybold-Hereaus S65B TRIVAC pumps. A combined pumping speed of 43 LPH (92 CFM) evacuates the dewar to a pressure of 800 Pa (6 torr). The helium flow rate was measured at the output of the vacuum pumps with a Teledyne-Hastings-Radist flow meter. A measured flow of 0.030 g/s (0.37 SCFM) corresponds to a 700-mW heat load into the bath.

A test signal port, required for maser tuning and calibration, is coupled to the maser input via a coaxial line (stainless-steel outer conductor/silver-coated beryllium copper inner conductor), a 5-dB attenuator, and a 35-dB waveguide directional coupler. The cooled attenuator and coupler reduce a 300-K ambient noise level at the test signal port to 0.03 K at the maser input. Two Gunn oscillators provide pump power to the maser amplifier.

A. Traveling-Wave Maser

The most economical and expedient means of providing a maser amplifier for this demonstration system was to use an available Block II-A maser structure [1], modifying it as necessary to accommodate operation at a lower physical temperature.

The Block II-A 8450-MHz maser amplifiers implemented in the DSN are installed in the vacuum environment of a closed-cycle helium refrigerator (CCR), and cooled by conduction to 4.5 K. The maser typically produces 40 to 45 dB of net gain over 100 to 115 MHz of bandwidth using 34 cm of total ruby length composed of four individual amplifier channels in cascade. Each amplifier channel, as shown disassembled in Fig. 3, is 8.5-cm long, with coupling probes at each end connected to the next section by short coaxial cables. The complete four-channel amplifier assembly is contained in a superconducting magnet, which provides the desired magnetic field for the ruby maser material and the yttrium-iron-garnet (YIG) isolators [2].

The input noise temperature of a maser amplifier assembly is approximately proportional to the physical temperature, while the electronic gain in decibels (excluding circuit losses) of a maser is approximately inversely proportional to the physical temperature. Therefore, while four maser channels are required at 4.5 K to provide 49 dB of electronic gain and 100 MHz of bandwidth, only one channel was needed to provide 47 dB of electronic gain with 76 MHz of bandwidth at 1.6 K.

The increased gain per unit length of the single maser channel, compared to the Block II-A maser, resulted in the need for increased reverse isolation per unit length. Yttrium-iron-garnet is distributed along the maser slow-wave structure to attenuate the signal propagation in the reverse direction, and prevent regenerative feedback. Our goal was to increase the reverse isolation from the Block II-A maser value of about 38 dB to about 100 dB per channel, while maintaining an adequate low level of forward loss (which adversely affects gain and noise temperature). A new isolator was designed, tested, and optimized in the single-channel, maser-amplifier structure operating at 4.5 K in a closed-cycle refrigerator. This isolator achieved approximately 74-dB reverse loss and 2.0-dB forward loss. The single-channel maser with this new isolator was integrated with the cryogenic feedhorn for system tests in the dewar. These system tests demonstrated that the isolator was marginally adequate at the lowest achievable bath temperature (1.6 K). Maser gain response, shown in Fig. 4, displayed some undesirable ripple (± 1 dB maximum) but was stable and satisfactory for system-noise temperature measurements. A sharp peak occurred in the maser gain at 8500 MHz due to inadequate isolator performance. The bandpass was tuned to a lower center frequency of 8400 MHz, instead of the typical 8450 MHz, to avoid this peak.

Table 1 lists the performance parameters of a typical Block II-A maser (operating at 4.5-K physical temperature), and the single-channel maser developed for this system, operating in a helium bath at 1.6 K.

B. Cooled Dual-Mode Horn

The goals for the cryogenic feedhorn design (as is the case with any cryogenic input transmission line) are to: (1) provide for a tolerable level of heat leak from ambient temperature to the helium bath, (2) provide minimum insertion loss at the signal frequency, and (3) reduce the feedhorn noise temperature contribution by cryogenically cooling as much of the horn as possible.

There are two high-quality X-band feedhorn designs that have been employed in the DSN: a wide bandwidth, corrugated horn that is presently used in the DSN, and a narrower bandwidth, smooth-walled, dual-mode horn. Neither horn design was suitable for cryogenic operation due to the thick aluminum wall construction. The coolable dual-mode horn used in the described system is a modified version of the DSN standard dual-mode horn, with the same overall dimensions, but built in two sections, the larger diameter section made of stainless steel and the smaller diameter section made of copper (Fig. 5).

The smaller diameter, 20.3-cm long, horn section was machined from copper to maintain its temperature isothermally with the bath temperature. This section of the horn accounts for nearly 60 percent of the microwave loss in the feedhorn, and maintaining it near the bath temperature virtually eliminates the noise contribution from it.

The larger diameter, 33.9-cm long, horn segment was machined from a solid billet of 304L stainless steel so that the flanges were an integral part of the horn. This was done to help maintain horn concentricity during and after fabrication. In addition to the top and bottom flanges, nine smaller flanges were machined onto the horn at 2.54-cm intervals. These flanges were used to attach perforated copper plates which serve to transfer heat from the feedhorn to the exiting helium vapor.

The perforated copper plates were 1.59-mm thick, perforated with 4.76-mm-diameter holes for a plate porosity of 33 percent. The outer diameters of the plates were kept within 1 mm of the neck diameter of the dewar to force the pumped vapors through the plate perforations. The operating temperatures of the plates are highly dependent on the helium vapor flow rate through the plates. The additional cooling provided by the vapor flow lowered the temperature along the stainless-steel horn section by up to 85 K, as compared to the calculated temperature profile of the horn with no helium vapor flow. The temperature profiles are shown for comparison in Fig. 6.

To minimize heat conduction from ambient temperature to the helium bath, the stainless steel horn wall was machined to a 1.0-mm thickness. This resulted in an acceptable heat leak of less than 0.25 W to the liquid bath. While the length and thickness of this horn section do not represent optimized dimensions for thermal considerations, they proved to be adequate for this demonstration.

The inside of the stainless horn section was copper plated to an average thickness of 2.3 microns (> 3 skin depths at 8400 MHz), which is sufficient to provide low microwave loss while not significantly adding to the conduction heat load to the bath.

Kapton polyimide film, 0.127-mm thick, was used at the horn aperture to serve as a vacuum window. This window contributes a noise temperature of approximately 0.1 K to the system noise temperature [3].

Low-density foam plugs (1.25-cm thick, dielectric constant of 1.04) were inserted in three places along the inside of the stainless horn section to serve as heat radiation blocks at intermediate temperatures. The top piece was

placed about 0.5 cm below the Kapton window and was just below room temperature, while the two lower plugs were placed about 10 and 20 cm below the Kapton window and were thus maintained at correspondingly lower temperatures. An estimated 0.04-K noise temperature is contributed by the top piece of foam, with smaller contributions from the colder foam plugs. The foam plugs also help prevent helium vapor circulation within the horn, thereby reducing the heat input due to convection.

III. System Tests

The assembled feedhorn-maser-dewar system and associated test equipment were moved to the roof of JPL's Building 238 to perform system-noise temperature measurements observing the sky. Figure 7 shows the experimental setup.

After filling the maser dewar with 4.2-K liquid helium, the maser's superconducting magnet and pump sources were energized and the maser gain response tuned to the desired frequency. Operating at an 8400-MHz center frequency, the gain of the maser at 4.2 K measured 13.5 dB.

The gain of the single-channel maser was measured at several different temperatures as the bath temperature was lowered to 1.6 K. A 7-dB increase in maser gain was measured (from 28 dB to 35 dB at 8400 MHz) upon cooling from 2.2 K to 2.17 K. This effect, shown in Fig. 8, is due to the onset of helium superfluidity at 2.17 K, which, with its very high effective thermal conductivity, insures that the ruby temperature is equal to the bath temperature. These test results suggest that above 2.17 K the ruby operates at a temperature about 0.5 K higher than that of the bath temperature.

The minimum bath temperature achieved was 1.6 K, which was determined by the helium boil-off rate and the size of the helium exhaust pumps. At 1.6 K, the maser exhibited a net gain of 43 dB, with a bandwidth of 76 MHz centered at 8400 MHz (shown in Fig. 4). The total system noise temperature measured 6.6 K with the feedhorn pointed at zenith. Of this 6.6 K, a calculated 2.8-K atmospheric noise contribution plus a 2.5-K "corrected" cosmic background noise temperature (see footnote in Table 2) implies that the input noise temperature of the feedhorn-maser system was 1.3 K (referenced to the feedhorn aperture). Table 2 summarizes these results.

Short-term gain and phase stability measured less than ± 0.02 dB and ± 0.3 deg, respectively, for 10-sec time intervals. During these measurements the temperature stability was better than ± 0.0002 K. No special attempts were made to increase the bath temperature stability.

IV. Conclusions

This demonstration has shown that an antenna feedhorn, waveguide feed components, and low-noise maser amplifier can be combined in a 1.6-K helium-cooled environment to achieve an extremely low input noise temperature—approximately 1.3 K. Use of such a system on a DSN antenna could reduce system noise temperatures by 2.4 dB, from 20 K (current 70-m Cassegrain feed, listen-only, zenith) to 11.5 K (future beam waveguide feed, listen-only, zenith). This system can best be utilized in an antenna environment that is nontipping and spacious enough to contain helium vacuum pumps and helium reliquefaction equipment. Such an environment will be available in the new beam waveguide antennas that the DSN will have in the 1990s.

Acknowledgments

The authors wish to thank the following people who helped with this project: Dan Hoppe for his calculations of the room-temperature horn noise temperature contributions; Mike Britcliffe for his assistance with the horn evaluations and for the use of his HEMT radiometer; Harry Reilly for his help with the Kapton window vacuum tests and valued discussions regarding feedhorns; and Steve Slobin for his calculations of the atmospheric noise temperature contributions.

References

- [1] D. L. Trowbridge, "Block IIA Traveling-Wave Maser," *TDA Progress Report 42-87*, Jet Propulsion Laboratory, Pasadena, California, pp. 158-164, November 15, 1986.
- [2] R. C. Clauss and R. B. Quinn, "Resonant Isolator for Maser Amplifiers," U. S. Patent 4,399,415, Issued 1983.
- [3] R. C. Clauss, H. F. Reilly, Jr., and M. S. Reid, "Low Noise Receivers: Microwave Maser Development," *JPL Space Programs Summary 37-62*, Jet Propulsion Laboratory, Pasadena, California, pp. 74-78, March 31, 1970.
- [4] C. T. Stelzreid, *The Deep Space Network—Noise Temperature Concepts, Measurements, and Performance*, JPL Publication 82-33, Jet Propulsion Laboratory, Pasadena, California, September 15, 1982.

Table 1. Performance of Block II-A maser and liquid-cooled maser compared

	Typical DSN Block II-A Maser	Maser Developed for This Demonstration
Center frequency, MHz	8450	8400
Maser structure temperature, K	4.5 ^a	1.6
No. of 8.5-cm ruby-filled channels	4	1
Electronic gain/unit length, dB/cm	1.4	5.6
Ruby absorption (A), dB	16.2	17
Inversion ratio (I = E/A)	3.0	2.8
Forward loss (copper and dielectric) (S), dB	7.5	2.5
Forward loss (due to isolator) Y, dB	1.5	2.5
Total forward loss (F = S + Y), dB	9	5.0
Total isolator reverse loss, dB	150	74
Calculated maser input noise temperature	3.4	1.0
Net gain (G = E - F), dB	40	43
Bandwidth (-3 dB) MHz	107	76

^aRuby bars cooled by conduction in a vacuum. Therefore, actual ruby temperature is assumed to be 5.0 K.

Table 2. Calculated feedhorn/maser noise temperatures

Center frequency	8400 MHz
Measured system noise temperature (A)	6.6 K
Measured atmospheric conditions (ground level):	
Altitude	0.4 km
Temperature	27.8 C
Pressure	0.0968 MPa
Relative humidity	30%
Calculated atmospheric noise contributions (from above data):	
Water vapor (B)	0.7 K
Oxygen (C)	2.1 K
Cosmic background (D)	2.5 K ^a
Resultant feedhorn/maser input noise temperature: (A-B-C-D)	
	1.3 K
Estimated component contributions to the above feedhorn/maser Input noise temperature:	
Feedhorn/window	0.15 K
Waveguide coupler, transitions, coax, VSWR loss	0.10 K
Test port noise leakage	0.03 K
Maser input noise temperature	1.00 K
Post amp noise contribution	0.02 K

^aThe "corrected" cosmic background noise temperature is 2.5 K (generally given as 2.7 K) as noted by Stelzreid in [4], which enables its use in simplified noise calculations that use the approximation for thermal noise $P_N = kTBG$.

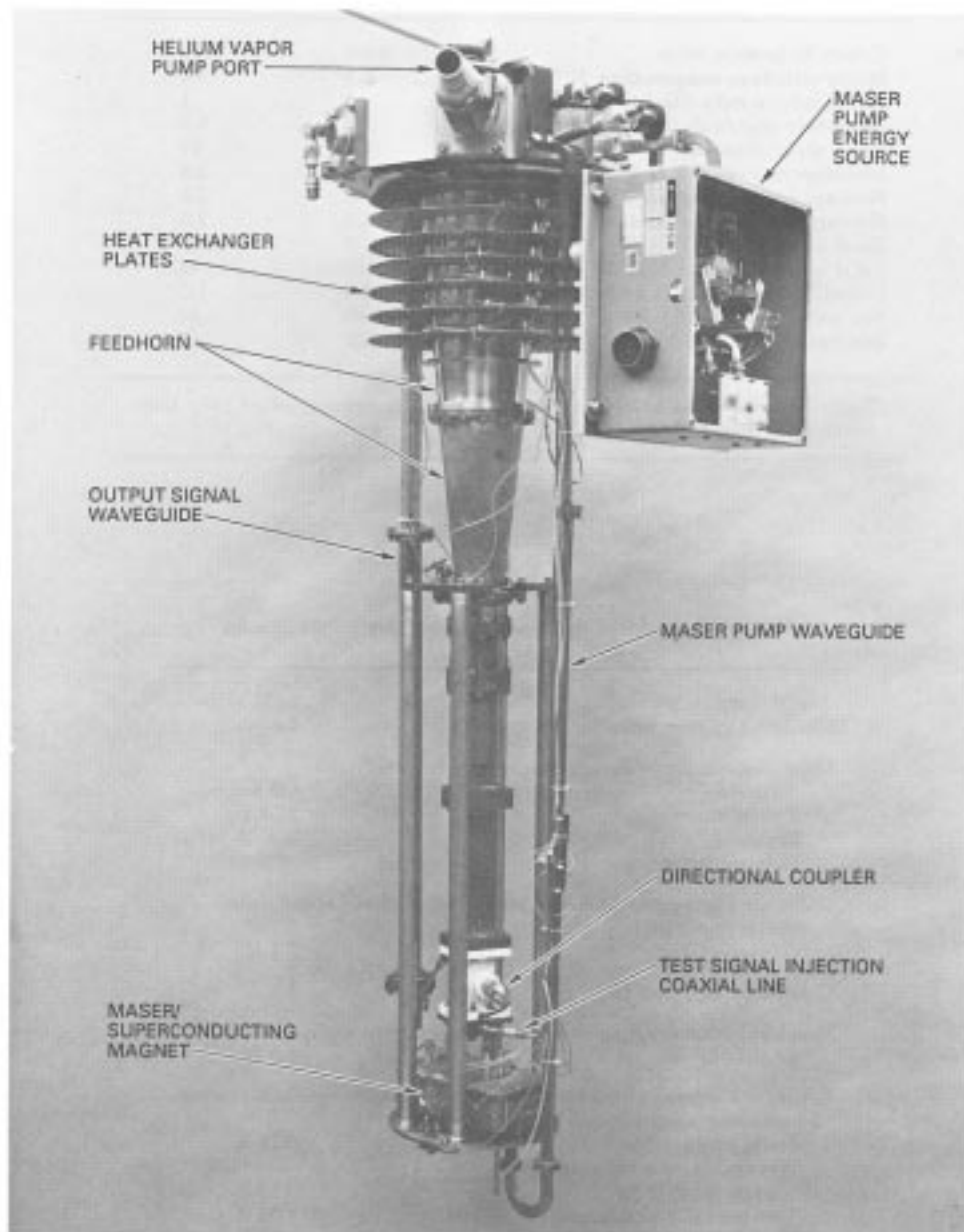

Fig. 1. Cryogenic feedhorn-maser assembly (shown removed from liquid helium dewar).

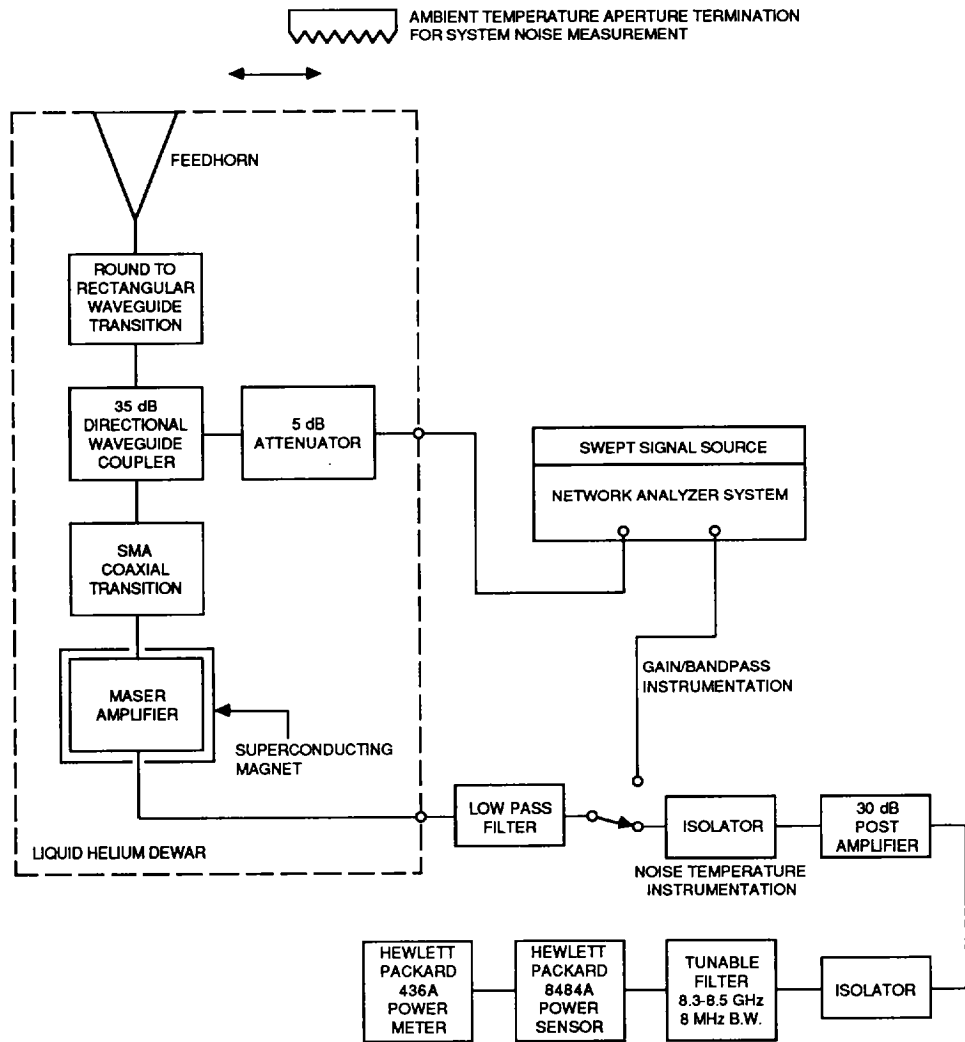

Fig. 2. Block diagram of cryogenic feedhorn-maser assembly and associated microwave instrumentation.

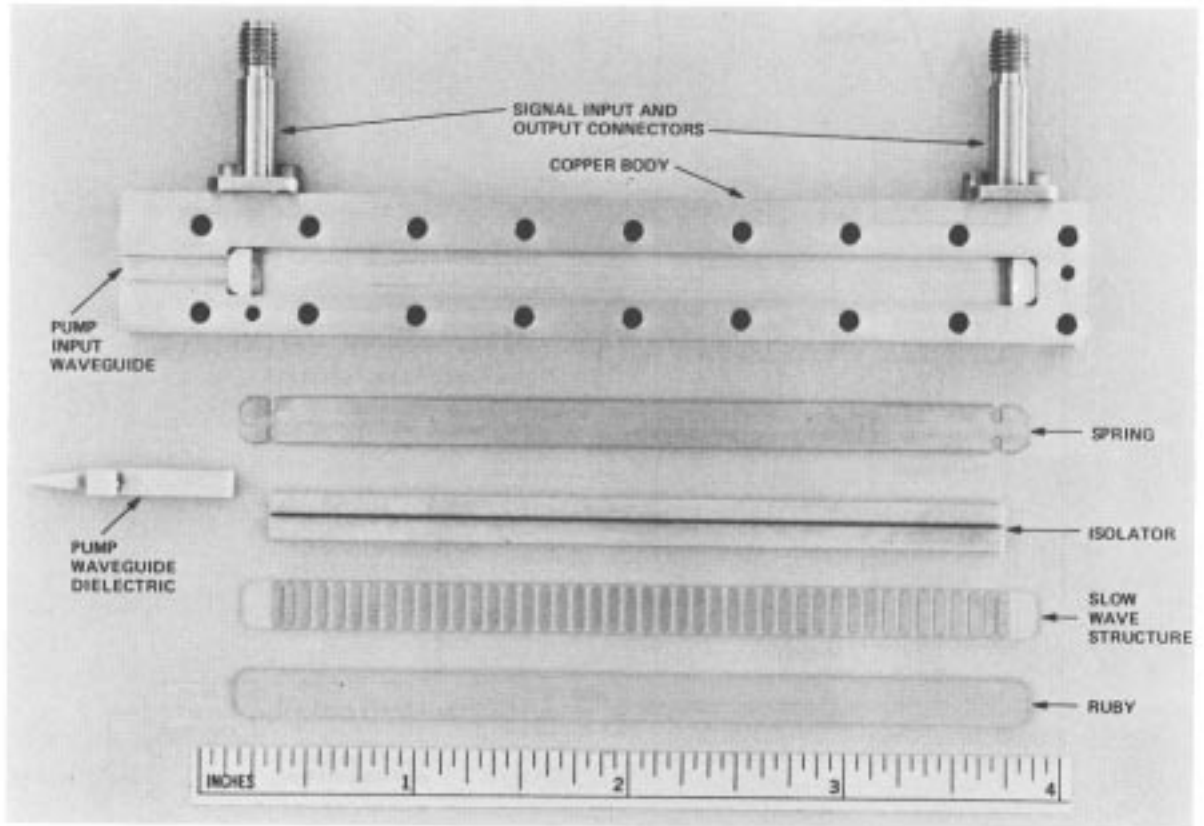

Fig. 3. 8.4-GHz traveling-wave maser structure (one of four channels).

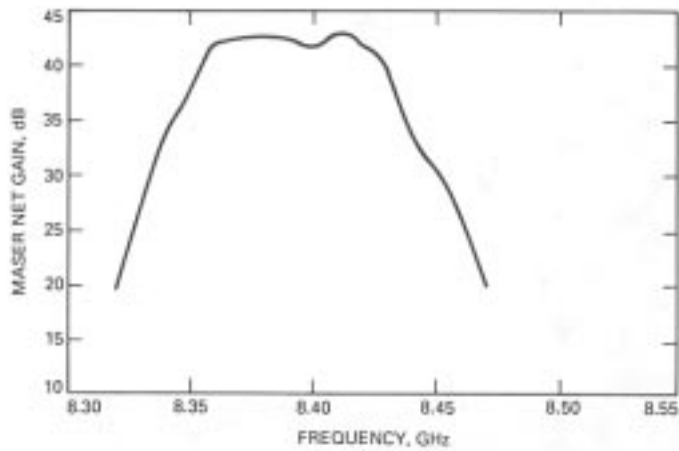

Fig. 4. Maser gain-bandpass at 1.64 K.

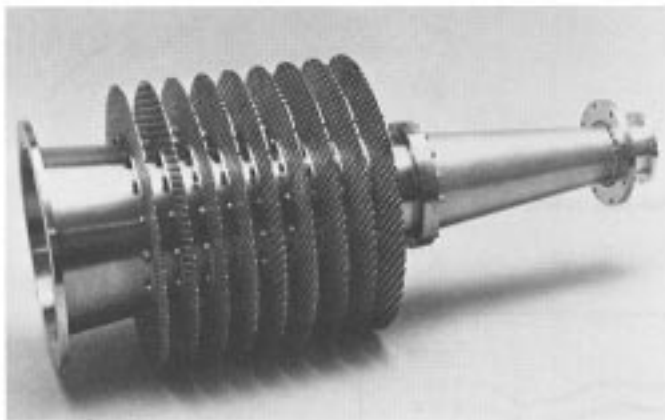

Fig. 5. Coolable dual-mode feedhorn.

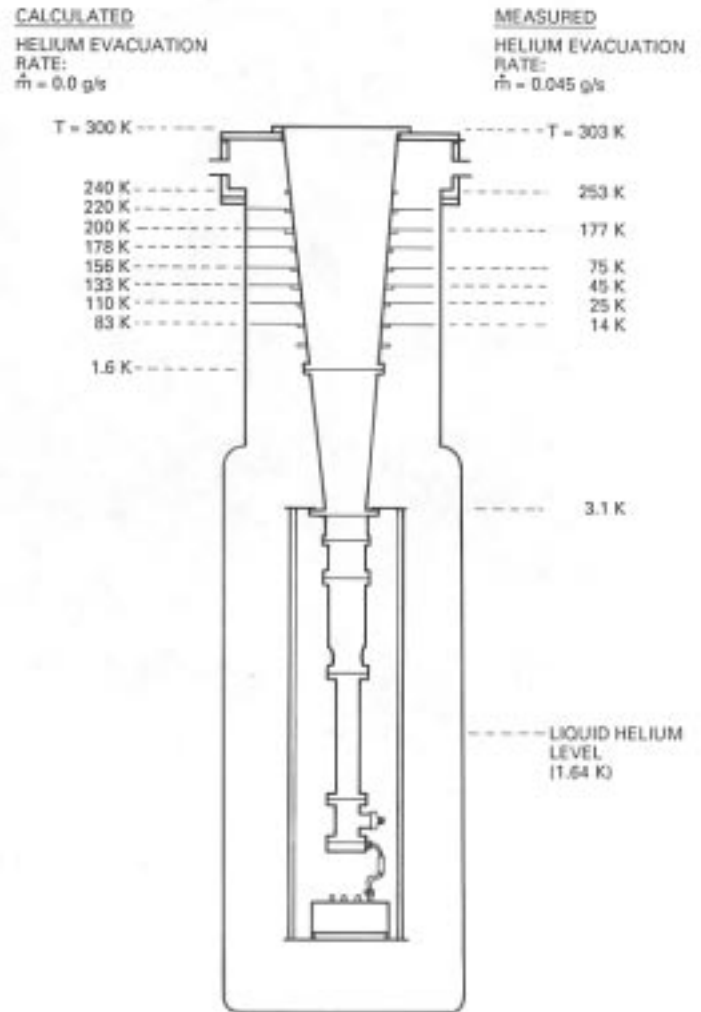

Fig. 6. Horn temperature profiles. The calculated values on the left represent the thermal gradient on the horn due to horn thermal conductivity only. The measured values on the right show the thermal gradient due to heat exchange with the exiting cold helium vapors.



Fig. 7. Rooftop system test setup.

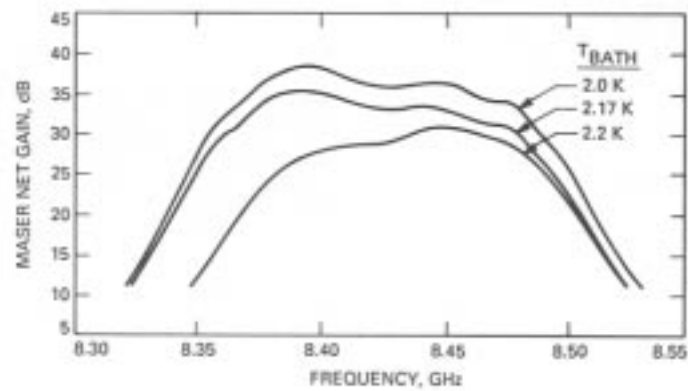

Fig. 8. Maser gain-bandpass as a function of temperature about the helium lambda point.