

Signal-to-Noise Ratio Losses in Full Spectrum Combining of Signals With a Downconverted Subcarrier

Y. Faria and J. Statman

Communications Systems Research Section

This article presents the results of the signal-to-noise ratio loss in the process of full spectrum combining of signals with a downconverted subcarrier under imperfect conditions. These imperfect conditions not only include the misalignment of the carrier, the subcarrier, and the symbols, but they also include the nonideal filtering in the subcarrier downconversion process, the cutoff of the data bandwidth, and the distortion in signal waveform.

I. Introduction

Arraying techniques have been used to improve the signal-to-noise ratio (SNR) by combining the signals from two or more antennas [3,4]. An overview of arraying schemes was given by Mileant and Hinedi [1], where symbol stream combining, baseband combining, carrier arraying, and full spectrum combining were described. In this work, the full spectrum scheme is employed; however, it differs slightly from the one described in [1]: The carrier frequency here is at a residual carrier frequency rather than at an intermediate frequency, and the subcarrier is downconverted to a lower frequency.

Analytical symbol SNR degradations in the arraying process are given in [1]; the degradations are generally lower than the SNR losses studied here. This study computes symbol SNR losses, the additional symbol SNR needed under the imperfect conditions to achieve the same symbol error rate as under the perfect conditions, through simulations.

This article presents the simulation results of symbol SNR losses in full spectrum combining of signals with a downconverted subcarrier under imperfect conditions. These conditions not only include the misalignment of the carrier, the subcarrier, and the symbols, but they also include the nonideal filtering, the data bandwidth cutoff, and the signal distortion. The simulated results of the SNR losses are compared with the theoretical symbol error probability for binary phase-shift keying (BPSK) for the considered symbol SNR.

The following cases are simulated:

- (1) For reference, a single antenna with known carrier phase, subcarrier phase, and symbol synchronization before the downconversion, and the group delay due to the downconversion as an integer multiple of the original sample period.
- (2) Two identical antennas under the same conditions as the reference.

- (3) Two identical antennas, one with a carrier phase jitter that has a normal distribution with a standard deviation of 0.1, 0.2, and 0.3 rad.
- (4) A 70-m antenna with a 34-m antenna under the same conditions as the reference.
- (5) A 70-m antenna with a 34-m antenna with a delay of one original sample period.

These cases are presented individually later, following a description of the general procedure.

II. General Procedure

A block diagram of the general procedure is depicted in Fig. 1 and is described as follows:

A square-wave subcarrier with a fundamental frequency of 22.5 KHz is modulated by a pseudo-random sequence with a clock time of 1/1000 sec. This signal is then sampled at a rate of 288 KHz and entered as the input to the down-mixing and arraying simulator. The sampled signal is then multiplied by a residual carrier of 100 Hz and its quadrature component to form the in-phase and the quadrature components of the simulated received signal from one antenna. For the received signal from another antenna, a phase jitter of the residual carrier is simulated by adding a random noise with a normal distribution and a standard deviation of σ_ϕ . This phase-jittered residual carrier and its quadrature component are multiplied by the input signal to form the simulated received signal from the other antenna.

The two pairs of the in-phase and quadrature components of the signals received from the two different antennas are then weighted according to the gain-noise temperature ratio of each antenna. A delay is added to one of the in-phase and quadrature pairs to simulate the asynchronization between the two antennas. To each of the signal components, an additive white Gaussian noise is added. The noises are assumed to be independent and identically distributed. The four noise-contaminated signal components are downconverted individually and decimated to a rate of 36 KHz. Note that the decimator outputs represent received signals that are recordable at a low rate. The downconverted in-phase and quadrature components from the two different antennas can now be weighted and added respectively, and this completes the combining part.

To remove the residual carrier, the in-phase and the quadrature components are multiplied by the residual carrier and its quadrature component, respectively. Taking

the delay due to the downconversion into account, the results are then added. Note that the delay, in this case, is considered as an integer multiple of the original sample period, thereby introducing a round-off error. The resulting signal is the input of the symbol detector, which consists of a multiplier of a square-wave subcarrier (at the lower frequency), and an integrate-and-dump filter (IDF). The symbols are finally obtained at the output of the IDF. Comparing the obtained symbols with the original pseudo-random noise (PN) sequence, the ratio of the number of wrong detections over the total number of symbols gives the symbol-error rate.

The five cases of simulation mentioned earlier are all special cases of this general procedure. The simulation conditions and results are presented in the following section.

III. Simulation Conditions and Results

A. A Single Antenna

For reference, a single antenna is simulated first. As a special case of the general procedure, the phase jitter of the carrier is set to zero, and one of the weights is set to one and the other, zero.

The average loss due to the downconversion is found to be 0.28 dB. Within this 0.28-dB symbol SNR loss, about a 0.15-dB loss is due to the data bandwidth cutoff, the other 0.13-dB SNR loss is due to the nonideal filtering, imperfect carrier and subcarrier phase compensation, and signal distortion due to the nonlinear phase of the down-converting system. Note that this loss agrees with the result of 0.28 dB obtained in a previous study [2]. The difference between this simulation and the previous one is that in this case, the residual carrier has a frequency of 100 Hz, whereas in the previous study, this frequency was considered zero.

B. Two Identical Antennas

When combining two identical antennas, all the weights are set to one, and the carrier phase jitter is set to zero.

The average gain over one antenna is 2.6885 dB, which is about 0.3 dB lower than the ideal of a 3-dB gain. This loss is about the same as in the reference since the accuracy of the results is about ± 0.02 dB as discussed in [2].

The results of the above two cases are shown in Figs. 2 and 3.

C. Two Identical Antennas With Carrier Phase Jitter

All the weights are set to one, and the phase jitter is set active with a standard deviation of 0.1, 0.2, and 0.3 rad.

The results are shown in Table 1 and Figs. 4 and 5. The losses include the losses due to the downconversion and the carrier phase jitter.

From Table 1, it can be observed that when the carrier phase jitter is small with a standard deviation of 0.1 rad, the loss due to the phase jitter is practically zero, and it increases gradually as the phase jitter increases.

D. A 70-m Antenna With a 34-m STD Antenna

Taking the larger antenna, the 70-m, as the reference, the weight for the 34-m standard (STD) antenna at S-band (2.2 to 2.3 GHz) is set to $\sqrt{0.17}$ [1]. The phase jitter is set to zero.

The average gain in the arraying is 0.3939 dB, which is 0.2861 dB lower than the 0.68-dB ideal gain. This loss is due to the downconversion and symbol detection as in the reference case.

E. A 70-m Antenna With a 34-m With a Delay of One Sample Period

The weights are set to one and $\sqrt{0.17}$ for the 70-m and the 34-m antennas, respectively. In addition, the delay

of the 34-m antenna is set to the value of one original sample period. This simulates the worst-case scenario of the imperfect delay compensation. Since the compensation can only be made as an integer multiple of a sample period, a misalignment can be a fraction of a sample period.

The result shows that the average gain over the 70-m antenna is about 0.0102 dB, which is 0.67 dB lower than the ideal gain. The loss is mainly due to the downconversion, symbol detection, and the delay. Since the downconversion and symbol detection cause about a 0.3-dB SNR loss, the 0.38-dB SNR loss is due to the delay misalignment.

The above results are shown in Figs. 6 and 7 in terms of symbol error rate versus the symbol signal-to-noise ratio.

IV. Conclusions

This article presents the symbol SNR losses due to the process of arraying of signals with a downconverted sub-carrier. The results show that the losses due to arraying may occur when the carrier phase jitter has a standard deviation greater than 0.1 rad. The loss due to asynchronization between two antennas may cause about a 0.38-dB loss. Under perfect carrier, subcarrier, and symbol alignment, the loss observed is about 0.28 dB, which is mainly due to the downconversion process, and it agrees with the results obtained in a previous study [2].

Acknowledgments

The authors thank Edgar Satorius for his many helpful suggestions and contributions to this work. The authors are also grateful to Sami Hinedi for his help in this work. Special thanks are due to Todd Chauvin, Laura Ekroot, Loretta Ho, and David Watola for their help in the simulation implementation. The JPL CRAY consulting team is also recognized for their very helpful support.

References

- [1] A. Mileant and S. Hinedi, "Overview of Arraying Techniques in the Deep Space Network," *The Telecommunications and Data Acquisition Progress Report 42-104*, vol. October–December 1990, Jet Propulsion Laboratory, Pasadena, California, pp. 109–139, February 15, 1991.

- [2] Y. Fera and J. Statman, "Symbol Signal-to-Noise Ratio Loss in Square-Wave Subcarrier Downconversion," *The Telecommunications and Data Acquisition Progress Report 42-112*, vol. October–December 1992, Jet Propulsion Laboratory, Pasadena, California, pp. 74–82, February 15, 1993.
- [3] J. S. Ulvestad, "Phasing the Antennas of the Very Large Array for Reception of Telemetry from Voyager 2 at Neptune Encounter," *The Telecommunications and Data Acquisition Progress Report 42-94*, vol. April–June 1988, Jet Propulsion Laboratory, Pasadena, California, pp. 257–273, August 15, 1988.
- [4] W. J. Hurd, J. Rabkin, M. D. Russel, B. Siev, H. W. Cooper, T. O. Anderson, and P. U. Winter, "Antenna Arraying of Voyager Telemetry Signals by Symbol Stream Combining," *The Telecommunications and Data Acquisition Progress Report 42-86*, vol. April–June 1986, Jet Propulsion Laboratory, Pasadena, California, pp. 131–142, August 15, 1986.

Table 1. Simulation conditions.

Carrier phase jitter, σ_ϕ	0.1	0.2	0.3
SNR gain, dB, over 1 ideal antenna	2.7241	2.5496	2.4280
SNR gain, dB, over 1 simulated antenna	2.9999	2.8254	2.7247
SNR loss, dB, compared to 2 ideal antennas	0.2759	0.4504	0.5720
SNR loss, dB, compared to 2 simulated antennas	-0.0356	0.1389	0.2605

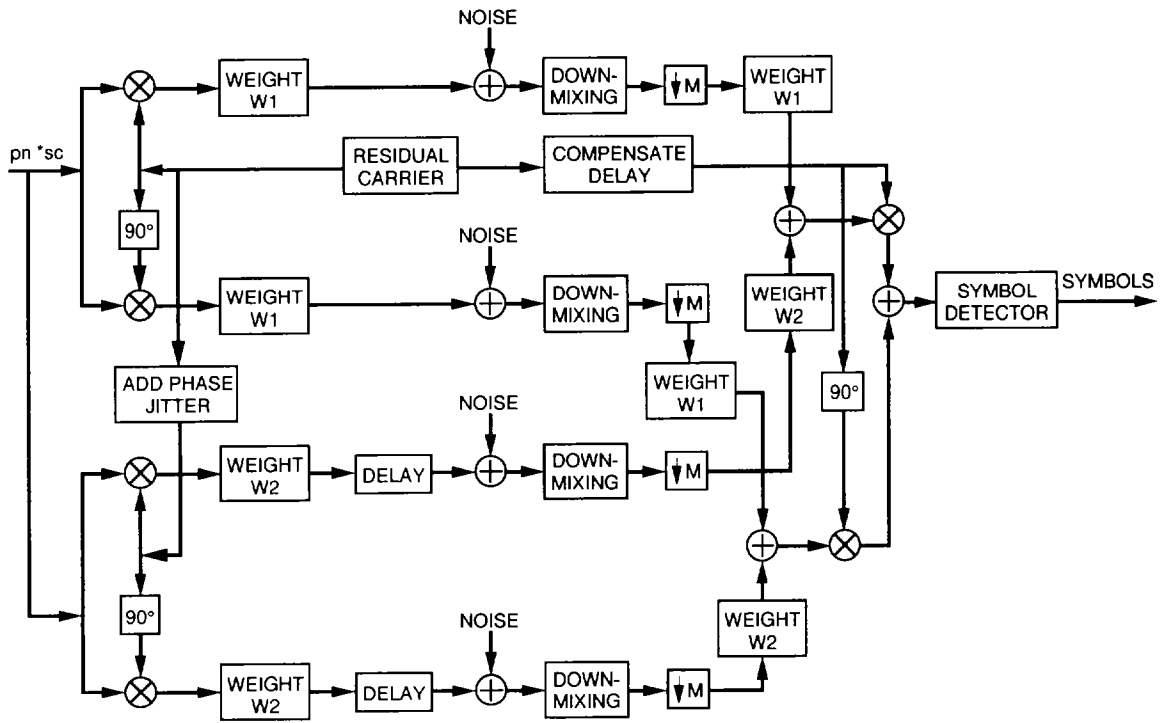

Fig. 1. The general procedure.

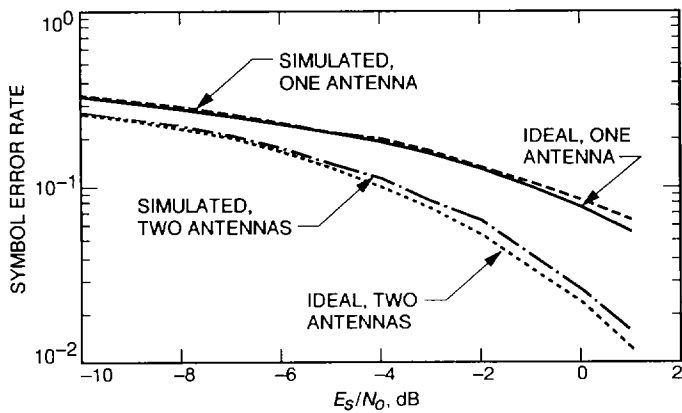

Fig. 2. Combining two identical antennas.

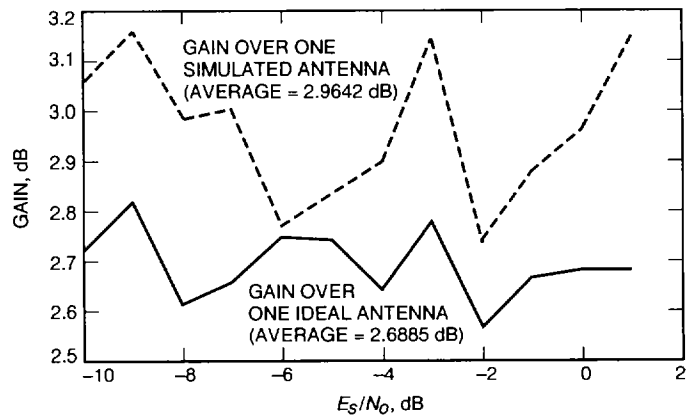

Fig. 3. Gain from combining two identical antennas.

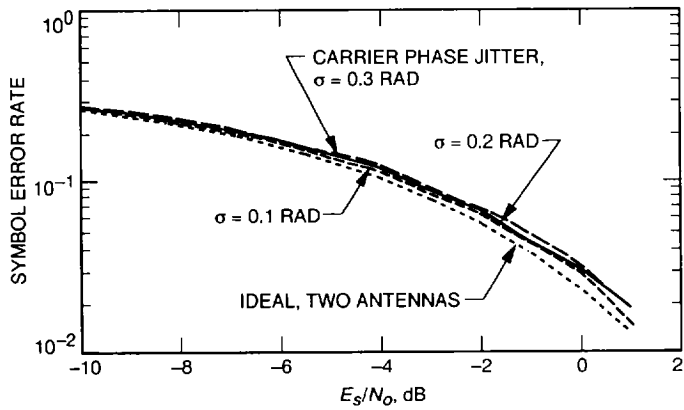

Fig. 4. Combining two identical antennas, one with carrier phase jitter.

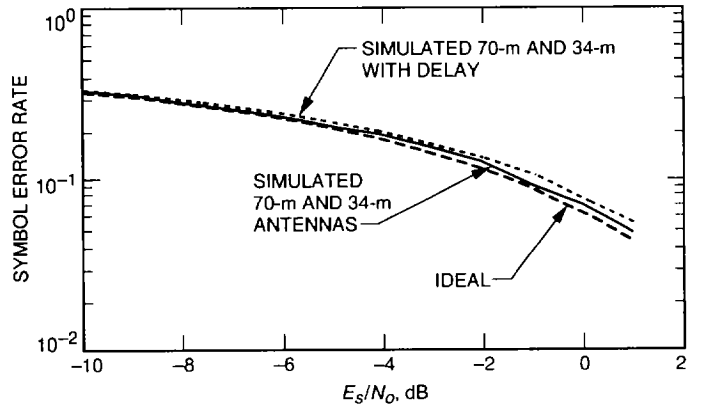

Fig. 6. Combining a 70-m and a 34-m antenna.

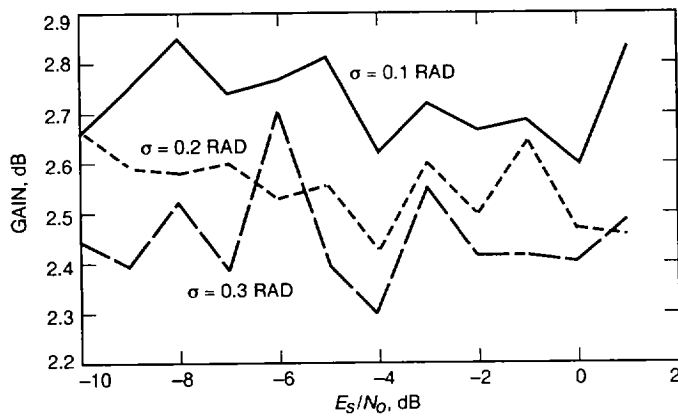

Fig. 5. Gain, dB, over one ideal antenna.

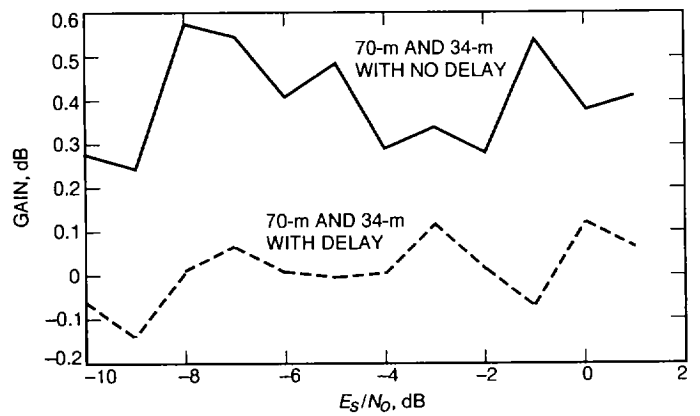

Fig. 7. Gain over the 70-m antenna.