

Energy Consumption Analysis of the Venus Deep Space Station (DSS-13)

N. V. Hayes

DSN Ground Antennas and Facilities Engineering Section

This report continues the energy consumption analysis and verification study of the tracking stations of the Goldstone Deep Space Communications Complex, and presents an audit of the Venus Deep Space Station (DSS 13). Due to the non-continuous radio-astronomy research and development operations at the station, estimations of energy usage were employed in the energy consumption simulation of both the 9-meter and 26-meter antenna buildings. A 17.9% decrease in station energy consumption was experienced over the 1979-1981 years under study. A comparison of the ECP computer simulations and the station's main watt-hour meter readings showed good agreement.

I. Introduction

In 1973, the Goldstone Deep Space Communications Complex (GDSCC) initiated an energy program in order to reduce its energy consumption following NASA guidelines. The program has the goal of reducing the consumption of purchased energy by 50% at the end of 1985 with the consumption level of 1975 used as a baseline.

In order to simulate the heating and cooling systems of the buildings under study, a computer model, the Energy Consumption Program (ECP), was developed (Ref. 1). Building construction parameters, weather conditions, and mechanical/electrical components usage are needed to calculate the energy consumption requirements of the building, the energy costs, and to suggest modifications of systems and procedures that would result in a reduction of energy usage.

The ECP model simulates the energy profile of a building in four consecutive steps. First, the heat loss or heat gain to the space under observation is computed. Second, the heating or cooling loads imposed on the air handlers are determined.

Third, the energy expenditure of the primary equipment or components that comprise the air-conditioning system such as boilers, compressors, heat pumps, etc. is calculated. The simulation yields data that describe daily, monthly, and yearly consumption for the building or buildings under study. Verification of the computer model is achieved through comparison of its results to actual watt-hour meter data.

The GDSCC is composed of four Deep Space Stations. Verification reports for the Echo (DSS 12) and Mars (DSS 14) stations were presented in previous reports (Refs. 2 and 3). The Pioneer Deep Space Station (DSS 11) is presently inactive. The Venus Deep Space Station (DSS 13), converted to a radio astronomy research and development site, is examined in the present report.

II. Energy Consumption Analysis

The Venus station is composed of two RF antennas; one 9-m (30-ft) and the other 26-m (85-ft) in diameter, and four-

teen support, storage, and control buildings. The buildings are listed by their function in Table 1. The energy consumption is itemized by equipment as follows: 1) electrical/electronic equipment, 2) mechanical equipment, 3) heating, ventilation, air-conditioning (HVAC) equipment, 4) accessories, and 5) lights. The electrical equipment category includes digital computers, RF transmitters, RF receivers, electronic racks, and other electrical/electronics equipment not related to HVAC. Mechanical equipment includes those heat-generating machines inside the air conditioned space such as machine shop equipment, air compressors and oil pumps. Auxiliary mechanical and electrical equipment associated with HVAC operation is listed separately under accessories. Accessories are that equipment necessary for the building's operation but which does not affect the space heating and cooling load calculations. All the accessories at Venus station are electrically powered. Air-handler fans, condenser fans (for air-cooled chillers), boiler pumps, and external building lights are electrically-powered accessories. The internal lighting equipment is classified according to type: incandescent or fluorescent.

Collimation towers (G-54, G-57, G-64, G-66) and building G-67 (Distilled Water Building) are not included in the ECP simulation because they are small consumers of energy. Building G-61 (100-kW Transmitter building) and the 9-meter antenna, G-55, are incorporated with Building G-58 (30-ft Hydro-Mech. and Transmitter Building), and the three buildings are treated as a unit. In the three years under study, 1979-1981, the 9-meter antenna experienced a sharp drop in use, and in 1981 it was shut down completely (see Table 2). The 26-meter antenna, G-52, also experienced a sharp drop in use over the years 1979-1981; for this reason the G-58 (9-meter antenna system) and the G-52 (26-meter antenna) ECP simulations are based on 1979 operations, a year of moderate antenna usage.

Table 2 is a record of 9- and 26-meter antenna hours of operation during 1979-1981. The hours of operation are not a direct method through which electrical consumption of the two antennas might be calculated because: (1) both receive and transmit times are included, and (2) the activity at the antenna site is not confined to direct antenna support. The station is a research and development site, in contrast with the Mars and Echo sites, which are primarily devoted to spacecraft tracking operations. Antenna utilization includes, but is not confined to, radar mapping and planetary radio astronomy. Transmitters (Klystron tube type) are inspected at the test bed located in the Transmitter Building (G-53A). Klystrons of up to 400 kW transmitting capability may be tested. The test bed's maximum capability, however, had not been utilized in the three years under study. Averages of test bed loads were used in the simulation.

Records of transmitter use and load per assignment were not consistently kept over the years 1979-1981 for the 26-meter antenna. This antenna was usually in the receive mode. Field estimates show that the 26-m antenna was in the transmit mode 20% of the operation time in 1979, 10% of the operation time in 1980, and very sporadically in 1981. The maximum transmitter output is 100 kW. The Klystron is only 40-60% efficient, and located in the air-conditioned electronics room on the antenna. No extravagant load is placed on the HVAC system, as the transmitter is cooled via water circulation effected by a 18.64 kW (25-hp) pump that is also outside the air-conditioned space. The hot water is cooled by a heat exchanger located outside the Transmitter Building. This cooling system expels 150 kW of heat when the 100 kW transmitter is in operation. For the 26-m antenna, the input parameters to ECP reflect the above considerations.

The 9-m antenna was always in transmit mode. The 9-m antenna (building G-55) consists of the 100 kW Transmitter building, G-61, and the 9-m (30-ft) Hydro-Mech Building, G-58. Adjacent to building G-58 is a 75 kW motor-generator set that supplies power to other parts of DSS 13, and is in continuous use.

III. Results

A month-by-month listing of the simulated energy consumption by each of the above five energy groups is given in Table 3. The station consumes 1418 $MWh_{(e)}$ of electrical energy and about 425 $MWh_{(t)}$ of gas heat on an annual basis. Monthly heating and cooling loads of the major buildings are presented in Tables 4 and 5, and depicted in Figs. 1 and 2. The monthly average and peak heating loads are 28 $MWh_{(t)}$ and 38 $MWh_{(t)}$, respectively. The monthly average and peak cooling loads are 52 $MWh_{(t)}$ and 75 $MWh_{(t)}$, respectively.

A. Electrical Energy Consumption

Figure 3 illustrates the distribution of electrical energy consumption, from Table 3, between electronic equipment, mechanical equipment, HVAC, accessories, and lights. The largest single consumer of energy at the site is the accessories (42% of the total). Electronics and mechanical (non-HVAC) equipment represent about 41% of the total consumption. HVAC equipment represents only about 13% of the total consumption. Figure 4 gives the electrical consumption of the entire Venus station on a monthly basis. The average consumption and peak monthly electrical energy consumption (from Table 3) are 118 and 127 $MWh_{(e)}$, respectively.

Table 6 presents the yearly electrical consumption for site buildings as simulated by ECP. Calculations show that the 26-meter antenna and the 9-meter antenna consumed 29.4%

of total site electrical consumption in 1979, 24% in 1980, and 17.3% in 1981.

Figures 5, 6, 7, and 8 indicate the buildings which are the major energy consumers in four categories: HVAC, electrical equipment, accessories, and lights. The Control Building, G-51, houses data acquisition/reduction equipment and is the largest HVAC consumer. It consumes 28.2% of total site electrical energy (Fig. 9), and 50% of the total station's HVAC expenditure (Fig. 5). The data acquisition and reduction equipment are kept at constant temperature.

The relative distribution of major building electrical consumption is shown also in Fig. 9. Buildings G-51 and G-53B have about the same energy expenditure. G-53B, the 26-m (85-ft) Hydro Mech. building, houses the drive system of the 26-meter antenna. The drive system is not in continuous use, but when it is employed, the electrical expenditure of this building can be significant.

B. Comparison of the ECP Simulations and the Watt-Hour Meter Data

The electrical energy for the station is supplied via DSS 12 by both the local utility, Southern California Edison Company, and by diesel engine generators. The Venus site has three metered substations. Other watt-hour meters have been installed by JPL to monitor buildings or specific equipment as in Fig. 10. All meters are read once a month. A review of the meter records was done for the years 1979-1981. There is generally no one-to-one correlation between meters and buildings. One meter may record the consumption of several buildings, or the consumption of one piece of equipment. The only one-to-one meter-building correlation available is for the Laboratory and Office Building (G-60). Its ECP simulation agreed with the meter readings to 4.6% over the three years under study.

The overall electrical consumption, as recorded at the three Edison substations decreased by 12.8% between 1979 and 1980, and 9.1% between 1980 and 1981. The site had a 17.6%

decrease in overall consumption between 1979 and 1981. This is primarily due to decreased antenna operation time.

For the 26-m antenna (G-52) and 9-m antenna (G-58), the simulated electrical consumptions obtained were added to the simulated consumptions for the other major buildings, and the combined result was compared to actual main site meter readings of record for 1979, 1980, and 1981. The simulation totals were found to be in accord with the meter reading totals.

IV. Summary

The ECP program allows a detailed analysis of energy consumption for a complex of buildings, or an individual building. In this study, estimates of antenna time and facilities usage were made because of the intermittent research and development activities at the site. When the ECP-simulations of the other buildings were compared to the main meter readings, total yearly consumption was verified over the three-year study period.

The ECP program allows also a categorization of energy consumption of the Venus station buildings. The computer simulations disclosed that the Control Building (G-51) is the largest consumer in the HVAC category due to its housing of data acquisition/reduction equipment. The simulation also revealed that G-51, the Control Building, and G-53B, the 26-m (85-ft) Hydro-Mech. Building, consumed equal amounts of electrical energy during 1979, a year of moderate antenna usage. This showed the considerable amount of power expended when the 26-m antenna drive system is in operation.

Most buildings at the Venus site are not individually metered. It is suggested that individual meters be installed to facilitate future energy audits. Updated single-line electrical drawings should be made. The meters should be inspected regularly. Also, a system of recording the 26-m antenna operation time, transmit and receive times and RF transmitter load for each assignment would give a better profile of the antenna energy consumption.

Acknowledgments

The author wishes to acknowledge the assistance of P. Stelzmuller and G. Glover in providing building and systems information necessary in the compilation of this report. G. Wischmeyer, K. Gwynn, E. Jackson, and A. Price of GDSCC supplied operational data and HVAC systems information. D. Schonfeld and F. Lansing edited the report.

References

1. Lansing, F. L., et al., "The Updated Algorithm of the Energy Consumption Program (ECP)," *TDA Progress Report 42-49*, Jet Propulsion Laboratory, Pasadena, CA, 1979, 107-115.
2. Gujar, C. N., Schonfeld, D., "Energy Consumption for the Echo Station (DSS-12)," *TDA Progress Report 42-66*, Jet Propulsion Laboratory, Pasadena, CA, September and October 1981, 355-363.
3. Hayes, N. V., "Energy Consumption Analysis for the Mars Deep Space Station," *TDA Progress Report 42-69*, Jet Propulsion Laboratory, Pasadena, CA, March and April, 1982, 200-207.

Table 1. Venus Station buildings

No.	Description
G-51	Control Building
G-52	26-m (85 ft) Antenna
G-53A	Transmitter Building
G-53B	26-m (85 ft) Hydro-Mech. Building
G-54	Collimation Tower
G-55	9-m (30 ft) Antenna
G-56	Security Building
G-57	Collimation Tower
G-58	9-m (30 ft) Hydro-Mech. and Transmitter Building
G-60	Laboratory and Office Building
G-61	100 kW Transmitter Building
G-62	Fire Line Pump House
G-63	Workshop and Warehouse
G-64	Collimation Tower
G-66	Collimation Tower
G-67	Distilled Water Building

Table 2. Antenna hours of operation – Venus Station

Month	26-m antenna			9-m antenna		
	1979	1980	1981	1979	1980	1981
Jan.	53	161	104	6	3	0
Feb.	157	135	179	12	2	0
Mar.	127	190	71	12	1	0
Apr.	113	142	136	10	0	0
May	206	121	234	19	6	0
Jun.	121	230	90	12	0	0
Jul.	146	201	131	11	0	0
Aug.	169	211	177	12	0	0
Sept.	80	117	162	17	0	0
Oct.	194	168	108	8	0	0
Nov.	143	114	45	10	0	0
Dec.	17	146	276	12	0	0
Total	1526	1936	1713	141	12	0

Table 3. Simulated energy consumption for the Venus Station, MWh

Month	Electrical accessories	Lights		Electronics equipment	Mechanical equipment	HVAC equipment		Other thermal equipment	Total electrical	Total thermal
		Incandescent	Fluorescent			Thermal	Electrical			
Jan.	48	2	3	31	23	40	10	2	117	42
Feb.	44	2	3	28	21	31	10	2	108	33
Mar.	48	2	3	31	23	33	11	2	118	35
Apr.	47	2	3	22	22	30	12	2	108	32
May	51	2	3	22	23	38	17	2	118	40
Jun.	51	2	3	22	22	32	22	2	122	34
Jul.	52	2	3	22	23	30	25	2	127	32
Aug.	52	2	3	22	23	31	25	2	127	33
Sept.	51	2	3	21	22	33	20	2	119	35
Oct.	49	2	3	31	23	28	15	2	123	30
Nov.	47	2	3	30	22	34	10	2	114	36
Dec.	48	2	3	31	23	41	10	2	117	43
Year Total	588	24	36	313	270	401	187	24	1418	425

Table 4. Major building heating load, MWh_(t)

Building	Month												Yearly Total
	Jan.	Feb.	March	April	May	June	July	Aug.	Sept.	Oct.	Nov.	Dec.	
G-51	23	18	20	18	26	23	22	22	23	17	20	23	255
G-53B	2	1	1	0	0	0	0	0	0	0	1	2	7
G-56	1.	0.4	0.4	0.2	0	0	0	0	0	0	0.5	1	3.5
G-60	10	7	7	6	5	3	3	3	4	5	7	10	70
G-62	1	0	0	0	0	0	0	0	0	0	0	1	2
G-63	1	0.3	0.3	0.2	0	0	0	0	0	0	0.3	1	3.1
Total	38	27	29	24	31	26	25	25	27	22	29	38	341

Table 5. Major building cooling load, MWh_(t)

Building	Month												Yearly Total
	Jan.	Feb.	March	April	May	June	July	Aug.	Sept.	Oct.	Nov.	Dec.	
G-51	28	27	31	31	38	40	43	42	39	33	29	27	408
G-52	0	1	1	2	3	4	5	5	4	3	1	0	29
G-53A	0	0	0	0	2	4	4	4	3	3	0	0	20
G-53B	2	2	3	3	6	7	8	8	7	3	3	3	55
G-58	0	0	0	0	1	2	2	2	1	0	0	0	8
G-60	6	7	9	9	7	10	12	11	9	10	8	6	104
G-63	0	0	0	0	0	1	1	1	1	1	0	0	5
Total	36	37	44	45	57	68	75	73	64	53	41	36	629

Table 6. Simulated yearly electric consumption for Venus Station Buildings

Building No.	Electrical consumption ^a KWh _(e)
G-51	398,191
G-52	207,558
G-53A	82,816
G-53B	371,655
G-56	15,150
G-58	207,543
G-60	110,109
G-62	2,523
G-63	17,398
Total	1,412,943

^a1979 meter reading is 1,416,480 KWh_(e)

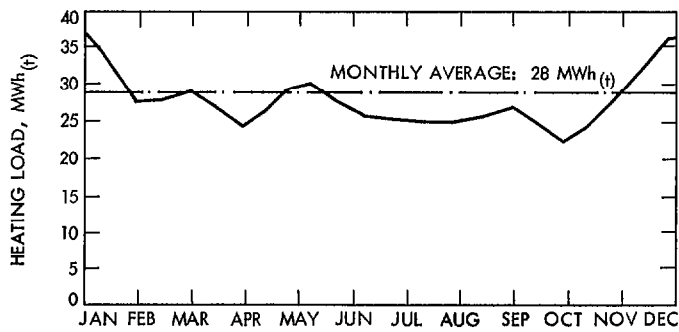

Fig. 1. Monthly heating load of the Venus Station

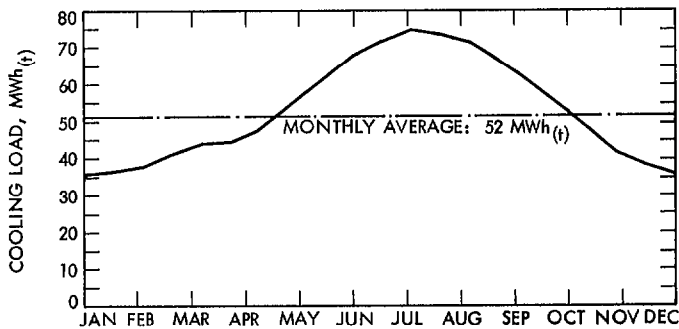

Fig. 2. Monthly cooling load of the Venus Station

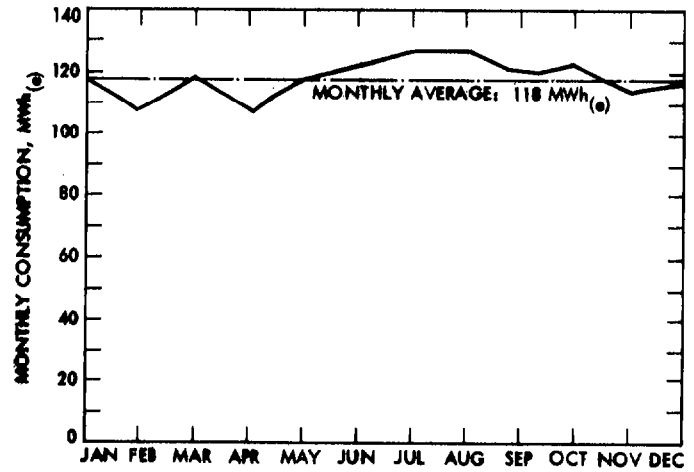

Fig. 4. Electrical consumption on a monthly basis, Venus Station

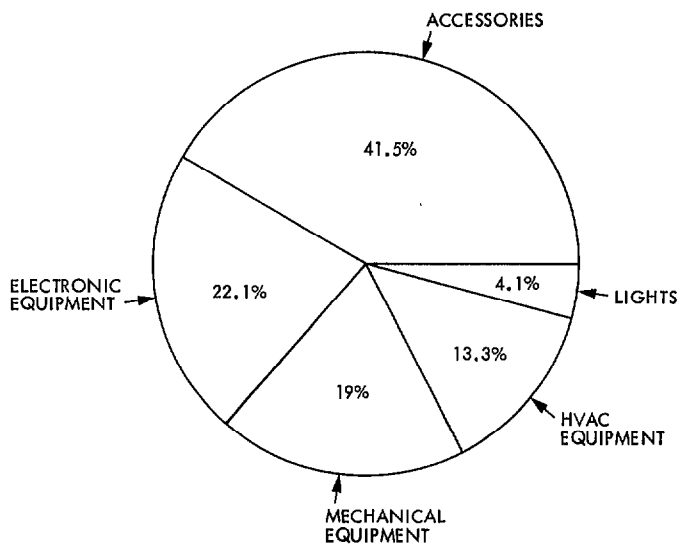

Fig. 3. Itemization of annual electrical consumption, Venus Station

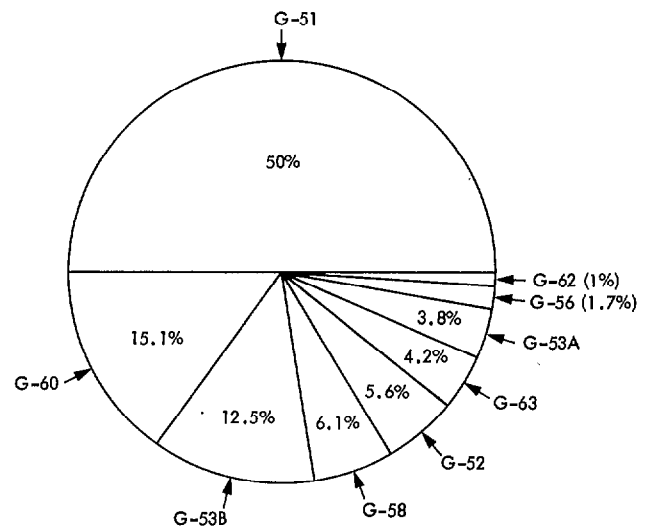

Fig. 5. Electrical consumption of HVAC equipment of major buildings, Venus Station

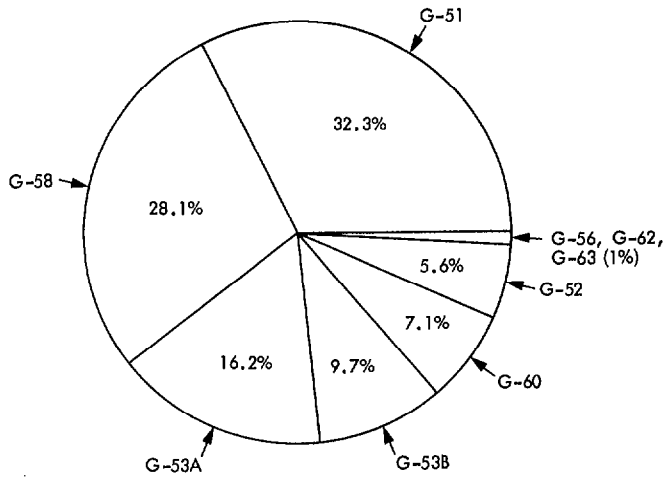

Fig. 6. Electrical/electronics equipment consumption of major buildings, Venus Station

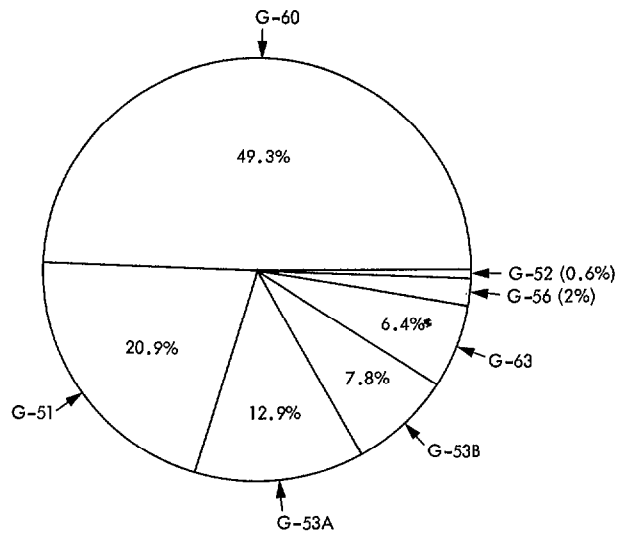

Fig. 8. Lighting consumption of major buildings, Venus Station

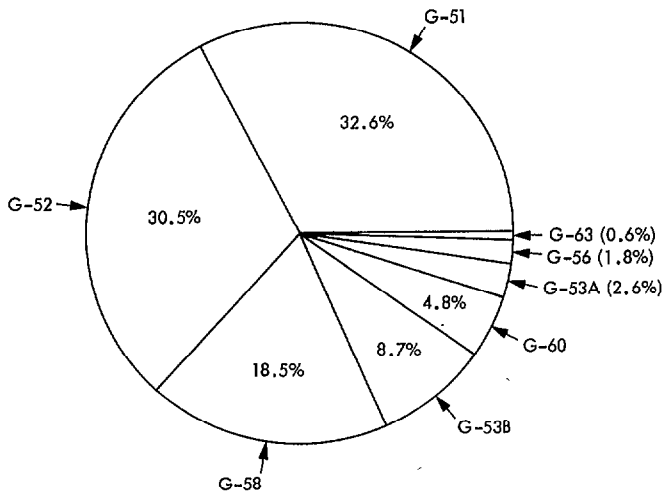

Fig. 7. Accessories consumption of major buildings, Venus Station

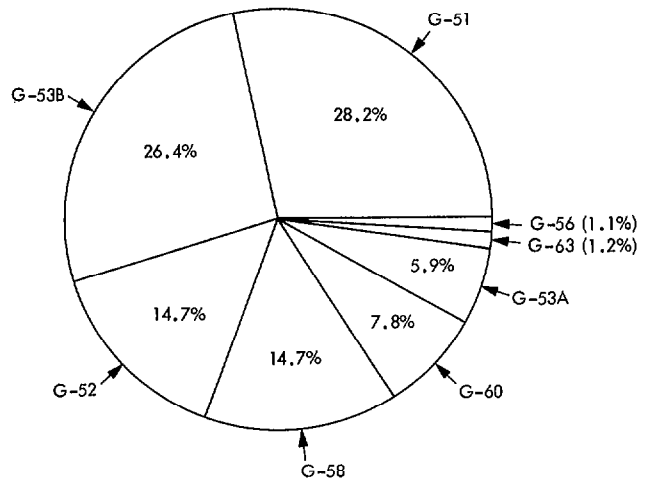

Fig. 9. Yearly electrical consumption of major buildings, Venus Station

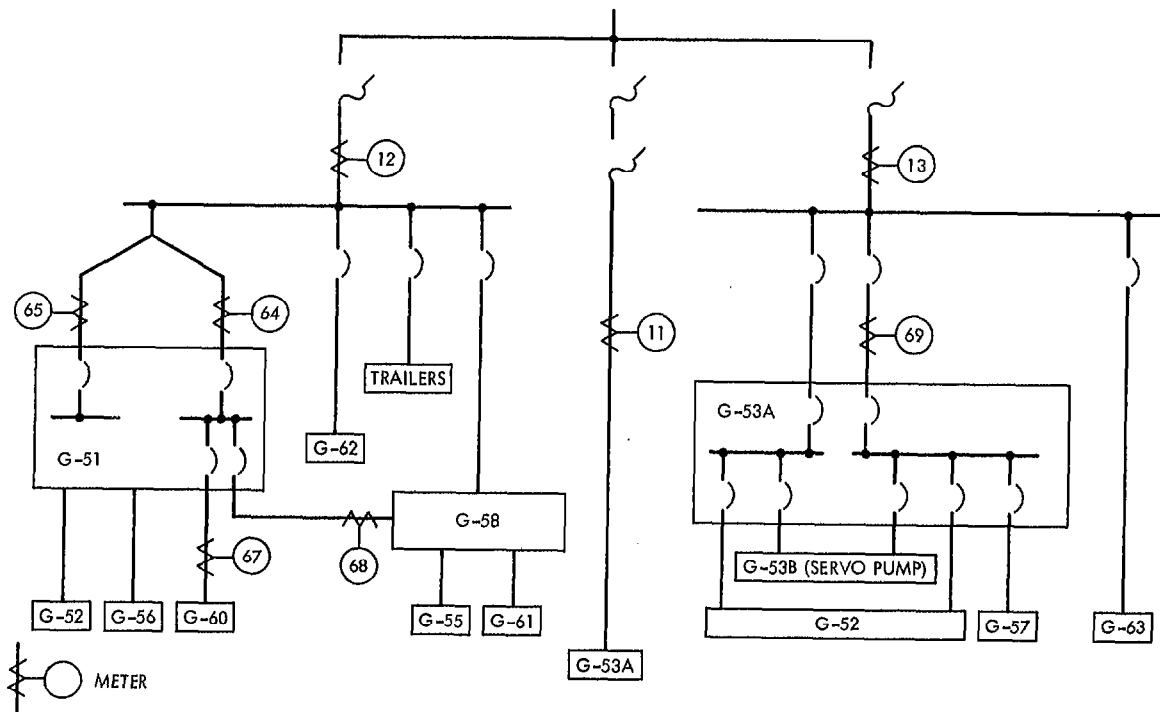

Fig. 10. Layout of watt-hour meters at Venus Station