

Performance Characteristics for an Array of Two Receiving Systems With Equal Apertures and Enhanced Radio Frequency Carrier Margin Improvement

M. H. Brockman

Telecommunications Science and Engineering Division

Enhanced radio frequency carrier margin improvement for arrayed receiving systems for coherent reception of phase modulated signals with residual carrier provides a significant reduction in carrier loop phase noise and an increase in the signal-to-noise ratio in the RF carrier tracking loop with an attendant reduction in telemetry radio loss. A significant increase in doppler frequency rate capability is also realized relative to operating at a narrower tracking loop bandwidth to obtain the same carrier sensitivity improvement. This report examines these performance characteristics for an array of two receiving systems with equal apertures and statistically independent prediction noise.

I. Introduction

A technique for providing enhanced radio frequency carrier margin improvement at low carrier margins has been described, and expected performance has been presented for a selected array of receiving systems with unequal apertures in Refs. 1 and 2. This report provides performance information for enhanced radio frequency carrier margin improvement for coherent carrier reception and demodulation of phase modulated signals with residual carrier for an array of two receiving systems with equal antenna apertures. Performance characteristics are presented that show RF carrier tracking loop phase noise reduction and signal-to-noise ratio improvement as well as enhanced RF carrier margin improvement. The performance presented herein is representative of a 34 meter-diameter high efficiency (listen only) antenna receiving system arrayed with a 34 meter-diameter antenna receiving system with transmit and receive capability. Comparative performance is discussed for the array and also to illustrate the increase in doppler rate capability for the two-receiver array relative to switching to a narrower tracking loop bandwidth with a single 34 meter-diameter receiving system. In addition, comparative RF carrier

performance is discussed for the two receiving system arrays (with 34-meter-diameter antennas) relative to a 64-meter-diameter antenna receiving system. In this report, the various components of operating system temperature (T_{op}) are treated as statistically independent for the two receiving systems of the array. A considerable portion of the following material in Section II and III of this report was presented in Ref. 1 and is included here for continuity of discussion.

II. Receiver Configuration

Figure 1 illustrates a method for achieving RF carrier arraying. A modification of Fig. 1 (so that much larger antenna separation for the array can be handled conveniently) was presented in Ref. 3 with a discussion of predetection noise resulting from operating equivalent system noise temperature T_{op} . Figure 2 illustrates a second configuration that provides additional filtering of receiving system 2 (through N) local oscillator phase noise which couples into receiving system 1 via the RF carrier summing junction. Consequently, Fig. 2 generally provides an increase in carrier margin relative to Fig. 1.

The received signal is an RF carrier (ω_{RF}) phase modulated with a square-wave subcarrier (ω_{sc}) at a peak modulation index m_{pd} that is, in turn, biphasic modulated with data $D(t)$.

$$\underbrace{2^{1/2} A \cos m_{pd} \cos \omega_{RF} t}_{\text{carrier}} + \underbrace{2^{1/2} A \sin m_{pd} \times D(t) \times \cos(\omega_{sc} t) \times \sin \omega_{RF} t + n(t)}_{\text{sidebands}} \quad (1)$$

The term $n(t)$ represents receiver noise which has a double-sided noise spectral density $N_o/2$.

III. Predetection Signal-to-Noise Ratio and RF Carrier Tracking Loop Phase Noise and Signal-to-Noise Ratio

The improvement in predetection carrier power-to-noise spectral density in receiving system 1 for two receiving systems arrayed (η_2) is

$$\eta_2 = \frac{\left[1 + \beta_2 \gamma_2 \left(\frac{N_{o2}}{N_{o1}} \right)^{1/2} \right]^2}{\left[1 + \frac{N_{o2}}{N_{o1}} \beta_2^2 \right]} \quad (2)$$

where β_2 is the voltage coupling of receiving system 2 relative to receiving system 1 at the summing junction. The term γ_2^2 is the ratio of the carrier power-to-noise spectral density ratio of receiving system 2 relative to the carrier power-to-noise spectral density ratio of receiving system 1. Receiving system 1 has a double-sided noise spectral density $N_{o1}/2$ related to T_{op1} and receiving system 2 has a double-sided noise spectral density $N_{o2}/2$ related to T_{op2} . Note that for N receiving systems

$$\eta_N = \frac{\left[1 + \beta_2 \gamma_2 \left(\frac{N_{o2}}{N_{o1}} \right)^{1/2} + \dots + \beta_N \gamma_N \left(\frac{N_{oN}}{N_{o1}} \right)^{1/2} \right]^2}{\left[1 + \frac{N_{o2}}{N_{o1}} \beta_2^2 + \dots + \frac{N_{oN}}{N_{o1}} \beta_N^2 \right]} \quad (3)$$

Consider the RF carrier phase tracking loop in receiving system 1 for the situation where the predetection IF filters F_{A2} through F_{AN} in receiving systems 2 through N have k times the noise bandwidth of predetection filter F_{A1} in receiving system 1. The RF carrier tracking loop is a second-order phase tracking loop which includes a bandpass limiter and a sinusoidal phase detector. With receiving system 1 only connected to the summing junction, the resultant rms phase noise

(σ_{ϕ_n}) at the output of the RF carrier tracking loop (i.e., on the first local oscillator) becomes (Ref. 2, Expression 4b):

$$\sigma_{\phi_n} = \frac{\frac{N_{o1}}{2} \cdot 2B_{L1}}{P_{c1}} \times \left[\frac{1 + \frac{P_{c1}}{NBW_{F_{A1}} \cdot N_{o1}}}{0.862 + \frac{P_{c1}}{NBW_{F_{A1}} \cdot N_{o1}}} \cdot \frac{\exp\left(\frac{N_{o1} B_{L1}}{P_{c1}}\right)}{\sinh\left(\frac{N_{o1} B_{L1}}{P_{c1}}\right)} \right]^{1/2} \quad (4)$$

radians, rms

where $P_{c1}/(NBW_{F_{A1}} \cdot N_{o1})$ is the RF carrier signal-to-noise power ratio at the input to the bandpass limiter in the carrier phase tracking loop. The term $NBW_{F_{A1}}$ represents the noise bandwidth of predetection IF filter F_{A1} in receiving system 1. The two-sided closed-loop noise bandwidth can be expressed as:

$$2B_{L1} = \frac{2B_{Lo1}}{r_o + 1} \left(1 + r_o \frac{\alpha_1}{\alpha_{o1}} \right) \quad (5)$$

where $r_o = 2$ by design at design point (0.707 damping) and $2B_{Lo1}$ is the design point (threshold) two-sided closed-loop noise bandwidth in receiving system 1. The term α_1 is the limiter suppression factor resulting from the noise-to-carrier power ratio due to $NBW_{F_{A1}}$ at the input to the bandpass limiter. The suppression factor α_1 has a value of α_{o1} at design point (threshold). At threshold, the predetection carrier-to-noise power ratio in a noise bandwidth equal to $2B_{Lo1}$ is unity (i.e., $P_c/(2B_{Lo} \cdot N_o) = 1$).

With receiving systems 1 and 2 connected to the summing junction, the RF carrier signal-to-noise power ratio at the input to the bandpass limiter is (Ref. 2, Expression 6)

$$\frac{P_{c1 \Sigma 1,2}}{P_{n1 \Sigma 1,2}} = \frac{(A_1 \cos m_{pd} + \beta_2 A_2 \cos m_{pd})^2}{\left[NBW_{F_{A1}} \cdot N_{o1} + \beta_2^2 NBW_{F_{A2}} \cdot N_{o2} \right]} \quad (6)$$

where m_{pd} is the peak phase modulation index, and $NBW_{F_{A2}} = k_2 \cdot NBW_{F_{A1}}$. Expression (6) can be rewritten as:

$$\frac{P_{c1 \Sigma 1,2}}{P_{n1 \Sigma 1,2}} = \frac{P_{c1}}{NBW_{F_{A1}} \cdot N_{o1}} \cdot \frac{\left[1 + \beta_2 \gamma_2 \left(\frac{N_{o2}}{N_{o1}} \right)^{1/2} \right]^2}{\left[1 + \frac{N_{o2}}{N_{o1}} \beta_2^2 k_2 \right]} \quad (7)$$

The change in RF carrier signal-to-noise power ratio at the input to the bandpass limiter in receiving system 1 is then:

$$\Delta_2 = \frac{\left[1 + \beta_2 \gamma_2 \left(\frac{N_{o2}}{N_{o1}} \right)^{1/2} \right]^2}{\left[1 + \frac{N_{o2}}{N_{o1}} \beta_2^2 k_2 \right]} \quad (8)$$

The limiter suppression factor due to the change in noise-to-carrier power ratio becomes $\alpha_{1\Delta 2}$ which provides a two-sided closed-loop noise bandwidth:

$$2B_{L1\Delta 2} = \frac{2B_{L1}}{r_o + 1} \left(1 + r_o \frac{\alpha_{1\Delta 2}}{\alpha_{o1}} \right) \quad (9)$$

The resultant rms phase noise at the output of the RF carrier tracking loop (i.e., on the first local oscillator in receiving system 1) becomes:

$$\sigma_{\phi_{n1\Sigma 1,2}} = \frac{\frac{N_{o1}}{2} \cdot 2B_{L1\Delta 2}}{P_{c1}} \cdot \frac{1}{\eta_2} \times \left[\frac{1 + \frac{P_{c1} \cdot \Delta_2}{NBW_{FA1} \cdot N_{o1}}}{0.862 + \frac{P_{c1} \cdot \Delta_2}{NBW_{FA1} \cdot N_{o1}}} \cdot \frac{\exp\left(\frac{N_{o1} \cdot B_{L1\Delta 2}}{P_{c1} \cdot \eta_2}\right)}{\sinh\left(\frac{N_{o1} \cdot B_{L1\Delta 2}}{P_{c1} \cdot \eta_2}\right)} \right]^{1/2} \quad \text{rad, rms} \quad (10)$$

Note that the total rms phase noise at the output of the RF carrier tracking loop (i.e., on the first local oscillator) in receiving system 1 for Fig. 1 is:

$$\left[\sigma_{\phi_{n1\Sigma 1,2}}^2 + \left(\frac{\beta_2 \sigma_{\phi_{n2}}}{1 + \beta_2} \right)^2 \right]^{1/2} \quad (11)$$

In Fig. 2, additional filtering of the output rms phase noise $\sigma_{\phi_{n2}}$ is provided by the local oscillator tracking loop in receiving system 2. Designate the additionally filtered rms phase noise as $\sigma'_{\phi_{n2}}$ which is less than $\sigma_{\phi_{n2}}$ by the square root of the ratio of local oscillator tracking loop noise bandwidth to $2B_{L2}$. Consequently for Fig. 2, $\sigma'_{\phi_{n2}}$ is substituted into expression (11) in place of $\sigma_{\phi_{n2}}$. Note that since receiving system 2 has the same first local oscillator as receiving system 1, receiving system 2 has effectively the same RF carrier characteristics and sensitivity as receiving system 1.

The rms phase noise (Expression [11]) represents a different RF carrier margin when compared to $\sigma_{\phi_{n1}}$ for receiving system 1 alone (Expression [4]). The change in RF carrier margin represents the enhanced carrier margin improvement for two receiving systems arrayed.

The RF carrier phase tracking loop in receiving system 2 is also a second-order phase tracking loop ($r_o = 2$) which utilized a bandpass limiter and sinusoidal phase detector. Since the closed loop noise bandwidth of the carrier phase tracking loop for receiving systems 2 through N is much narrower (by design) than that in receiving system 1, phase noise in receiving system 1 carrier tracking loop produces a reduction in pre-detection signal-to-noise ratio for receiving systems 2 through N . The resultant predetection carrier signal-to-noise ratio in receiving system 2 for two systems arrayed is then

$$\frac{P_{c2\Sigma 1,2}}{P_{n2}} = \frac{P_{c2} \left(1 - \frac{\sigma_{\phi_{n1\Sigma 1,2}}^2}{2} \right)^2}{NBW_{FA2} \cdot N_{o2}} \quad (12)$$

which produces an rms phase noise

$$\sigma_{\phi_{n2\Sigma 1,2}} = \frac{\frac{N_{o2}}{2} \cdot 2B_{L2}}{P_{c2\Sigma 1,2}} \times \left[\frac{1 + \frac{P_{c2\Sigma 1,2}}{NBW_{FA2} \cdot N_{o2}}}{0.862 + \frac{P_{c2\Sigma 1,2}}{NBW_{FA2} \cdot N_{o2}}} \cdot \frac{\exp\left(\frac{N_{o2} \cdot B_{L2}}{P_{c2\Sigma 1,2}}\right)}{\sinh\left(\frac{N_{o2} \cdot B_{L2}}{P_{c2\Sigma 1,2}}\right)} \right]^{1/2} \quad \text{rad, rms} \quad (13)$$

Consider the signal-to-noise ratio (SNR) of the RF carrier phase tracking loop in receiving system 1. Using the linear theoretical model (Refs. 4 and 5), the RF carrier tracking loop SNR (ρ_{L1}) for receiving system 1 by itself is:

$$\rho_{L1} = \frac{P_{c1}}{N_{o1} B_{L1} \Gamma_1} \quad (14)$$

where Γ_1 is the bandpass limiter performance factor:

$$\Gamma_1 = \frac{1 + \frac{P_{c1}}{NBW_{FA1} N_{o1}}}{0.862 + \frac{P_{c1}}{NBW_{FA1} N_{o1}}} \quad (15)$$

With receiving system 1 and 2 connected to the summing junction, the RF carrier tracking loop SNR in receiving system 1 for the array is:

$$\rho_{L1\Sigma 1,2} = \frac{P_{c2} \eta_2}{N_{o1} B_{L1\Delta 2} \Gamma_{1\Delta 2}} \quad (16)$$

where

$$\Gamma_{1\Delta 2} = \frac{1 + \frac{P_{c1} \cdot \Delta_2}{NBW_{FA1} \cdot N_{o1}}}{0.862 + \frac{P_{c1} \cdot \Delta_2}{NBW_{FA1} \cdot N_{o1}}} \quad (17)$$

IV. Performance

Performance characteristics are presented in this report for an array of two receiving systems which are representative of a 34 meter-diameter high efficiency (listen only) antenna receiving system and a 34 meter-diameter antenna receiving system with transmit and receive capability. The sets of design parameters for receiving system 1 are:

Threshold Two-Sided Noise Bandwidth		
$2B_{Lo1}$	2.0	48 Hz
Predetection IF Filter Noise Bandwidth		
NBW_{FA1}	2200	2200 Hz

while the corresponding set of parameters for receiving system 2 are:

Threshold Two-Sided Noise Bandwidth		
$2B_{Lo2}$	1	1 Hz
Predetection IF Filter Noise Bandwidth		
NBW_{FA2}	$k_2 \cdot NBW_{FA1}$	$k_2 \cdot NBW_{FA1}$
Local Oscillator Tracking Loop Two-Sided Noise Bandwidth (Fig. 2)		
	1	1 Hz

Performance is presented for the case where receiving system 1 of the array represents a 34-meter-diameter high efficiency

antenna and also for the case where receiving system 1 of the array represents a 34 meter-diameter antenna with transmit and receive capability.

Consider first the case where receiving system 1 is representative of a 34 meter-diameter high efficiency (listen only) antenna and receiving system 2 is representative of a 34-meter-diameter transmit and receive antenna. For this situation, $\gamma_2 = 0.88$ (-1.11 dB) and the ratio of noise spectral densities (N_{o2}/N_{o1}) (of receiving system 2 relative to receiving system 1) is 1.16 ($21.5k/18.5k$). Figure 3 shows the rms phase noise $\sigma_{\phi_{n1}}$ at the output of the RF carrier phase tracking loop (i.e., on the first local oscillator) for receiving system 1 by itself as a function of initial RF carrier margin (carrier level above design point) for $2B_{Lo1} = 12$ Hz as calculated from Eq. (4) in Section III. Figure 3 also shows the total rms phase noise (Eq. [11]) at the output of the RF carrier tracking loop in receiving system 1 for the array of receiving systems 1 and 2 for $k_2 = 3.5$ and 9 with $\beta_2 = 1.0$. Total rms phase noise is shown for array configurations that are representative of Figs. 1 and 2.

In Fig. 3, note that with receiving system 1 by itself (prior to arraying) initially at 5 dB above design point threshold (carrier margin), the rms phase noise for the array ($k_2 = 3.5$) is 23.8 and 23.3 degrees respectively for array configurations representative of Figs. 1 and 2. These rms phase noise values represent an enhanced RF carrier margin of 9.3 and 9.6 dB respectively when compared to the phase noise characteristics of system 1 by itself. This corresponds to an improvement in receiving system 1 carrier margin of 4.3 and 4.6 dB respectively for $k_2 = 3.5$ (see Fig. 4). The corresponding performance values for the array, with $k_2 = 9$ and an initial carrier margin of 5 dB for receiving system 1, are 20.2 and 19.9 degrees rms phase noise at the output of the RF carrier tracking loop for receiving system 1 which represents an enhanced RF carrier margin of 11.5 and 11.7 dB respectively for array configurations representative of Figs. 1 and 2. This corresponds to an improvement in the receiving system 1 carrier margin of 6.5 and 6.7 dB respectively for $k_2 = 9$, (see Fig. 4). Continuing as above, Fig. 4 shows enhanced RF carrier margin improvement for receiving system 1 as a function of initial RF carrier margin for $k_2 = 3.5$ and 9 with $2B_{Lo1} = 12$ Hz.

It should be noted, in Fig. 4, that at a 5 dB initial RF carrier margin for receiving system 1 (by itself) and with receiving systems 1 and 2 arrayed ($k_2 = 9$), the two-sided closed loop noise bandwidth $2B_{L1\Delta 2}$ (Eq. [9]) of the RF carrier tracking loop in receiving system 1 is 12 Hz (design point noise bandwidth). With $k_2 = 3.5$, $2B_{L1\Delta 2}$ for receiving system 1 is 12 Hz at slightly less than a 2 dB initial RF carrier margin for receiving system 1 by itself prior to arraying. At

this 2 dB initial RF carrier margin, the enhanced RF carrier margin for the array ($k_2 = 3.5$) is 6.2 dB (2 + 4.2 dB) and carrier cycle slipping will occur in the RF carrier phase tracking loop. The recommended minimum DSN RF carrier margin is 10 dB which occurs at an initial RF carrier margin for receiving system 1 (by itself) of 5.7 dB. Figure 5 shows the effect of varying the voltage coupling β_2 of receiving system 2 relative to receiving system 1 at the summing junction on enhanced RF carrier margin improvement ($2B_{L_{o1}} = 12$ Hz) for $k_2 = 3.5$ and 9 with a 10 dB initial RF carrier margin for receiving system 1 (prior to arraying).

Consider next the signal-to-noise ratio (SNR) of the RF carrier phase tracking loop in receiving system 1 for this first case. Figure 6 shows the RF carrier loop SNR for receiving system 1 by itself (ρ_{LI}) as a function of initial RF carrier margin as calculated from Eq. (14) above for $2B_{L_{o1}} = 12$ Hz. Note the interrelationship provided by Figs. 3 and 6 between rms phase noise at the output of the RF carrier tracking loop and the tracking loop SNR. Using this relationship, the total rms phase noise (Eq. [11]) at the output of the RF carrier tracking loop in receiving system 1 for the two receiving system array provides the RF carrier loop SNR in receiving system 1 also shown in Fig. 6 for array configurations representative of Figs. 1 and 2 for $k_2 = 3.5$ and 9 with the design parameters discussed above. The RF carrier loop SNR for receiving system 1 with the two receiving system array calculated from Eq. (16) above provides essentially the same characteristics as the array configuration representative of Fig. 2 due to the additional local oscillator filtering in receiving system 2. At an initial RF carrier margin of 2 dB for $k_2 = 3.5$ and 5 dB for $k_2 = 9$, the RF carrier loop SNR calculated from Eq. (16) is 0.2 dB greater than the carrier loop SNR for the array configuration representative of Fig. 2. This difference decreases to zero at about a 10 dB RF carrier margin. Note the 2.6 dB and 2.8 dB improvement in the system 1 receiver RF carrier tracking loop signal-to-noise ratio for $k_2 = 3.5$ in Fig. 6 for the two receiving system array relative to system 1 by itself initially at 5 dB above design point (carrier margin). The corresponding improvement in the system 1 receiver RF carrier tracking loop SNR is 4.1 dB and 4.3 dB for $k_2 = 9$.

Figures 7, 8 and 9 show performance characteristics (which are similar to Figs. 3, 4 and 6) for the same array as above with $2B_{L_{o1}} = 48$ Hz and $\beta_2 = 1.0$ for $k_2 = 3.5$ and 9. In this case ($2B_{L_{o1}} = 48$ Hz), the RF carrier loop SNR calculated from Eq. (16) above provides the same characteristic in Fig. 9 as the array configuration representative of Fig. 2 due to the additional local oscillator filtering in receiving system 2.

Consider the second case where receiving system 1 is representative of a 34 meter-diameter transmit and receive antenna

and receiving system 2 is representative of a 34 meter-diameter high efficiency (listen only) antenna. For this case, $\gamma_2 = 1.14$ (+1.11 dB) and the ratio of noise spectral densities (N_{o2}/N_{o1}) is 0.86. Figure 10 shows the rms phase noise for receiving system 1 by itself as a function of initial RF carrier margin and for the array of receiving systems 1 and 2 for $k_2 = 3.5$ and 9, $2B_{L_{o1}} = 12$ Hz and $\beta_2 = 1.6$ (as calculated from Eqs. [4] and [11]) with array configurations that are representative of Figs. 1 and 2. Figure 11 shows the resulting enhanced RF carrier margin improvement for receiving system 1 (similar to Fig. 4) for this array. In Fig. 11, with system 1 by itself initially at a 5 dB carrier margin, the improvement in the receiving system 1 carrier margin is 5.9 and 6.2 dB respectively with $k_2 = 3.5$ for array configurations representative of Figs. 1 and 2. The corresponding improvement in receiving system 1 carrier margin is 7.9 and 8.2 dB with $k_2 = 9$. Figure 12 shows the effect (for this array) of varying the voltage coupling β_2 of receiving system 2 relative to receiving system 1 at the summing junction on enhanced RF carrier margin improvement ($2B_{L_{o1}} = 12$ Hz) for $k_2 = 3.5$ and 9 with a 10 dB initial RF carrier margin for receiving system 1 (prior to arraying). The signal-to-noise ratio (SNR) of the RF carrier phase tracking loop in receiving system 1 for this second case is shown in Fig. 13 (see discussion relative to Fig. 6). In Fig. 13, the improvement in the system 1 receiver RF carrier tracking loop SNR for $k_2 = 3.5$ is 3.5 and 3.7 dB for the two receiving system array relative to system 1 by itself initially at 5 dB carrier margin. The corresponding improvement in the system 1 receiver RF carrier tracking loop SNR is 4.8 and 5 dB for $k_2 = 9$.

Figures 14, 15 and 16 show performance characteristics (which are similar to Figs. 10, 11 and 13) for the same (second case) array as above with $2B_{L_{o1}} = 48$ Hz and $\beta_2 = 1.6$ for $k_2 = 3.5$ and 9. The RF carrier loop SNR calculated from Eq. (16) in Section III provides the same characteristics in Fig. 16 as the array configuration representative of Fig. 2 due to the additional local oscillator filtering in receiving system 2.

Initial measurements of enhanced carrier margin improvement have been made in the laboratory with $\gamma_2 = 1$. The measurement was made with a predetection filter noise bandwidth of 2200 Hz with a $2B_{L_{o1}}$ of 152 Hz for system 1 and a $2B_{L_{o2}}$ of 1 Hz with $k_2 = 3.5$ for system 2 with $N_{o2}/N_{o1} = 1$. Measured RF carrier margin improvement was 3.2 dB at an initial RF carrier margin of 14.5 dB for receiving system 1 (prior to arraying) with $\beta_2 = 0.9$. Predicted performance is 3.35 dB. At this same 14.5 dB initial RF carrier margin, measured carrier margin improvement was 2.4 dB for $\beta_2 = 0.54$ while predicted performance is 2.7 dB. Description of the Laboratory measurement technique was presented in Ref. 6.

V. Discussion

Performance characteristics for an array of two receiving systems with equal antenna apertures for $k_2 = 3.5$ and 9 are presented in this report that show RF carrier tracking loop phase noise reduction and signal-to-noise ratio improvement as well as enhanced RF carrier margin improvement. The two receiving systems are representative of a 34 meter-diameter high efficiency (listen only) antenna receiving system and a 34 meter-diameter antenna receiving system with transmit and receive capability. The performance presented with the figures and accompanying discussion in the preceding section of this report for $2B_{L_{o1}} = 12$ and 48 Hz show that receiving system 1 of the array can be representative of either the 34 meter-diameter high efficiency (listen only) antenna or the 34 meter-diameter antenna with transmit and receive capability.

With system 1 of the array representative of a 34 meter-diameter high efficiency antenna receiving system (first case), the array has a minimum received RF carrier level capability that is 1.1 dB more sensitive than for the second case with the 34 meter-diameter antenna receiving system with transmit and receive capability as system 1. However, comparison of Figs. 4 and 11 for $2B_{L_{o1}} = 12$ Hz and of Figs. 8 and 15 for $2B_{L_{o1}} = 48$ Hz at equal input signal levels above minimum carrier level capability show that the array for the second case has up to 0.6 dB greater RF carrier margin than for the first case. Note that reception of the same signal represents 1.1 dB less initial RF carrier margin for case 2 relative to case 1. Also, comparison of Figs. 6 and 13 for $2B_{L_{o1}} = 12$ Hz and of Figs. 9 and 16 for $2B_{L_{o1}} = 48$ Hz at equal input signal levels show that the array for the second case has up to 0.4 dB greater RF carrier tracking loop signal-to-noise ratio than for the first case.

As discussed in Refs. 1 and 2, the reduction in rms phase noise on the first local oscillator (System 1) for the two system receiver array raises the point of switching to a narrow bandwidth in the RF carrier tracking loop to accomplish reduction in rms phase noise and achieve essentially the same carrier margin improvement with a single receiving system. Consider operation of the array with $2B_{L_{o1}} = 48$ Hz compared to operation of a single 34 meter-diameter antenna receiving system by itself with $2B_{L_o} = 12$ Hz. Operation of the receiving system by itself at a $2B_{L_o} = 12$ Hz relative to operation with $2B_{L_o} = 48$ Hz improves the carrier margin by 48/12 or 6 dB. Consequently, operation of the receiving system with $2B_{L_o} = 12$ Hz at a 11 dB RF carrier margin corresponds to operation with $2B_{L_o} = 48$ Hz at a 5 dB initial carrier margin. At a 11 dB carrier margin ($2B_{L_o} = 12$ Hz), the single receiving system has a RF carrier doppler rate capability of 12.4 Hz/sec for a 10 degree phase error in the RF carrier tracking loop (Fig. 17). With the same receiving system as system 1 of a two system array (presented herein) operating with a $2B_{L_{o1}} = 48$ Hz at an initial carrier margin of 5 dB, the doppler rate

capability for a 10 degree phase error (due to doppler rate) is 85 Hz/sec for $k_2 = 3.5$ and 57 Hz/sec for $k_2 = 9$ (Fig. 18). The 85 Hz/sec for $k_2 = 3.5$ represents a 6.8 times improvement in doppler rate capability while the improvement is 4.6 times for $k_2 = 9$ relative to the single system with $2B_{L_o} = 12$ Hz.

A preliminary comparison of RF carrier performance can also be made between the two receiving system arrays with 34 meter-diameter antennas described above ($2B_{L_{o1}} = 12$ or 48 Hz) and a 64 meter-diameter antenna receiving system operating by itself with $2B_{L_{o1}} = 10$ or 30 Hz (Ref. 1). It should be noted that reception of the same signal by the 34-meter and 64-meter receivers represents the following relative RF carrier margins. An array with a 34-meter-diameter high efficiency antenna for receiving system 1 ($2B_{L_{o1}} = 12$ Hz) has 5.2 dB less initial RF carrier margin (system 1) than a 64 meter-diameter antenna receiving system ($2B_{L_o} = 10$ Hz). This difference in RF carrier margin becomes 6.5 dB for $2B_{L_{o1}} = 48$ Hz (system 1) and $2B_{L_o} = 30$ Hz (64 m). An array with a 34-meter-diameter antenna with transmit and receive capability for receiving system 1 ($2B_{L_{o1}} = 12$ Hz) has 6.3 dB less initial RF carrier margin (system 1) than a 64-meter-diameter receiving system ($2B_{L_o} = 10$ Hz). This difference in RF carrier margin becomes 7.6 dB for $2B_{L_{o1}} = 48$ Hz (system 1) and $2B_{L_o} = 30$ Hz (64 m). The following comparison applies down to a minimum RF carrier level which provides an initial 5 dB carrier margin for receiving system 1 of the array.

Consider the situation where doppler rate is small enough so that it is not a primary consideration. With receiving system 1 of the array representative of either of the 34-meter-diameter antennas, $k_2 = 9$ and $2B_{L_{o1}} = 12$ Hz, the array would provide improved (1 to 2 dB) performance (lower RF carrier loop rms phase noise and higher RF carrier tracking loop signal-to-noise ratio) relative to a 64-meter-diameter antenna receiving system ($2B_{L_{o1}} = 10$ Hz). With $2B_{L_{o1}} = 12$ Hz and $k_2 = 3.5$, the array with either 34-m antenna as system 1 would provide slightly reduced performance (fraction of a dB less) relative to a 64-meter-diameter antenna receiving system ($2B_{L_{o1}} = 10$ Hz). With $k = 9$ and $2B_{L_{o1}} = 48$ Hz, the array with either 34-m antenna as system 1 would provide equivalent performance (essentially equal RF loop rms phase noise and RF loop SNR) to a 64-meter-diameter antenna receiving system ($2B_{L_o} = 30$ Hz). With $2B_{L_{o1}} = 48$ Hz and $k_2 = 3.5$, the array would provide reduced performance (1 to 2 dB less) relative to a 64-meter-diameter antenna receiving system ($2B_{L_o} = 30$ Hz).

Next consider the situation where doppler rate is a prime consideration. With receiving system 1 of the array representative of either of the 34-meter-diameter antennas, $k_2 = 3.5$ and $2B_{L_{o1}} = 48$ Hz, the array would provide essentially the

same doppler rate capability as a 64-meter-diameter antenna receiving system ($2B_{L_o} = 30$ Hz – Ref. 1, Fig. 7). With $2B_{L_{o1}} = 48$ Hz and $k_2 = 9$, the array would provide about 2/3 the doppler rate capability of a 64-meter-diameter

receiving system ($2B_{L_o} = 30$ Hz). With $2B_{L_{o1}} = 12$ Hz, the array would provide about 2/3 ($k_2 = 3.5$) and about 1/2 ($k_2 = 9$) the doppler rate capability of a 64-meter-diameter antenna receiving system ($2B_{L_o} = 10$ Hz).

References

1. Brockman, M. H., "Performance Characteristics for an Array of Two Receiving Systems with Unequal Predetection Signal-to-Noise Ratios and Enhanced Radio Frequency Carrier Margin Improvement," *TDA Progress Report 42-84*, Jet Propulsion Laboratory, Pasadena, California, February 15, 1986.
2. Brockman, M. H., "Enhanced Radio Frequency Carrier Margin Improvement for an Array of Receiving Systems with Unequal Predetection Signal-to-Noise Ratios," *TDA Progress Report 42-76*, pp. 170-188, Jet Propulsion Laboratory, Pasadena, California, February 15, 1984.
3. Brockman, M. H., "The Effect of Partial Coherence in Receiving System Noise Temperature on Array Gain for Telemetry and Radio Frequency Carrier Reception for Similar Receiving Systems," *TDA Progress Report 42-66*, pp. 219-235, Jet Propulsion Laboratory, Pasadena, California, December 15, 1981.
4. Tausworthe, R. C., "Limiters in Phase-Locked Loops: A Correction to Previous Theory," *Space Programs Summary No. 37-54*, Vol. III, pp. 201-203, Jet Propulsion Laboratory, Pasadena, California, 1968.
5. Divsalar, D., and Yuen, J. H., "Improved Carrier Tracking Performance with Coupled Phased-Locked Loops," *TDA Progress Report 42-66*, pp. 148-171, Jet Propulsion Laboratory, Pasadena, California, December 15, 1981.
6. Brockman, M. H., "The Effect of Partial Coherence in Receiving System Noise Temperature on Array Gain for Telemetry and Radio Frequency Carrier Reception for Receiving Systems with Unequal Predetection Signal-to-Noise Ratios," *TDA Progress Report 42-72*, pp. 95-117, Jet Propulsion Laboratory, Pasadena, California, February 15, 1983.

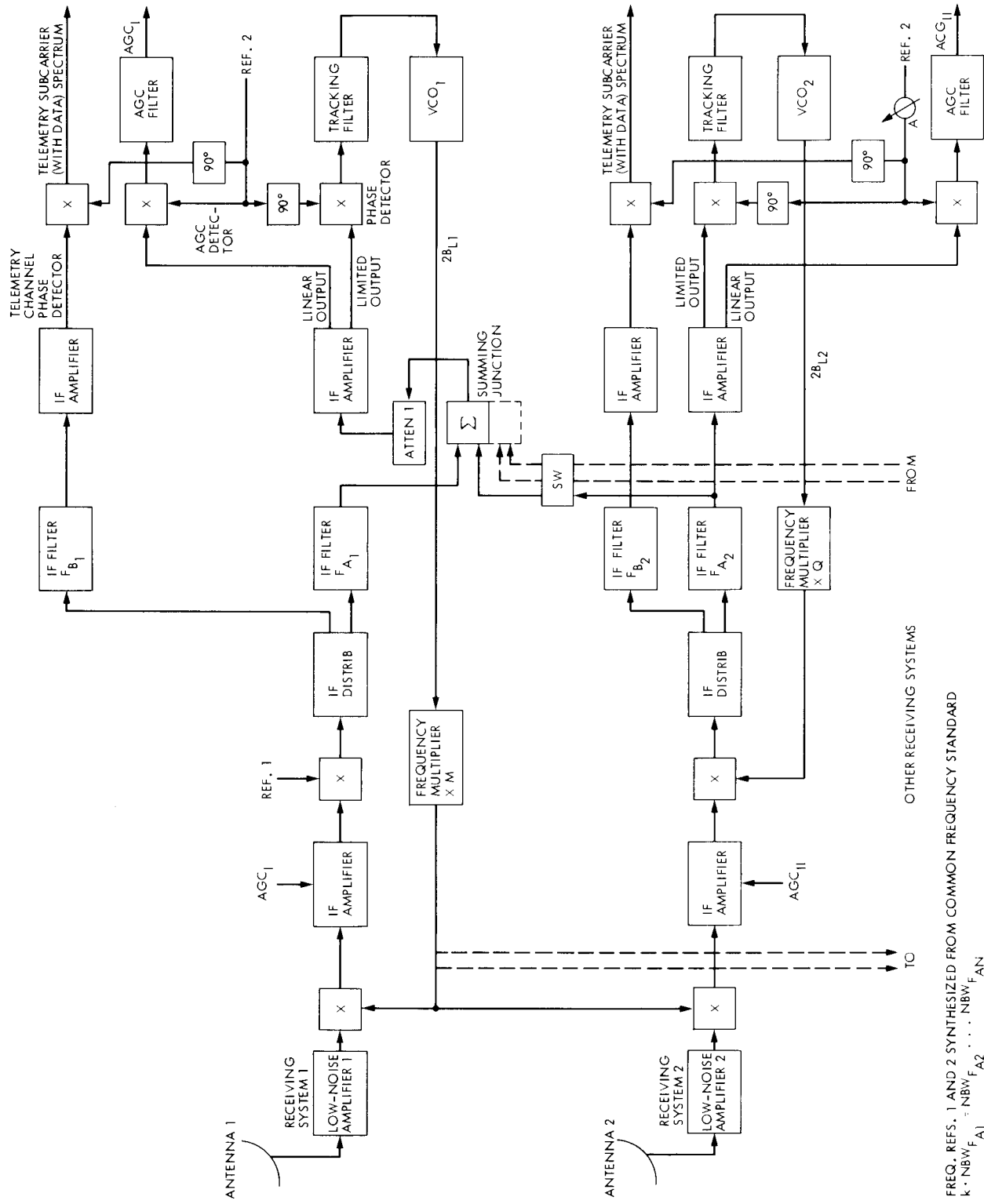

FREQ. REFS. 1 AND 2 SYNTHESIZED FROM COMMON FREQUENCY STANDARD
 $k \cdot NBW, F_{A1} = NBW, F_{A2} \dots NBW, F_{AN}$

Fig. 1. Enhanced radio frequency carrier arraying

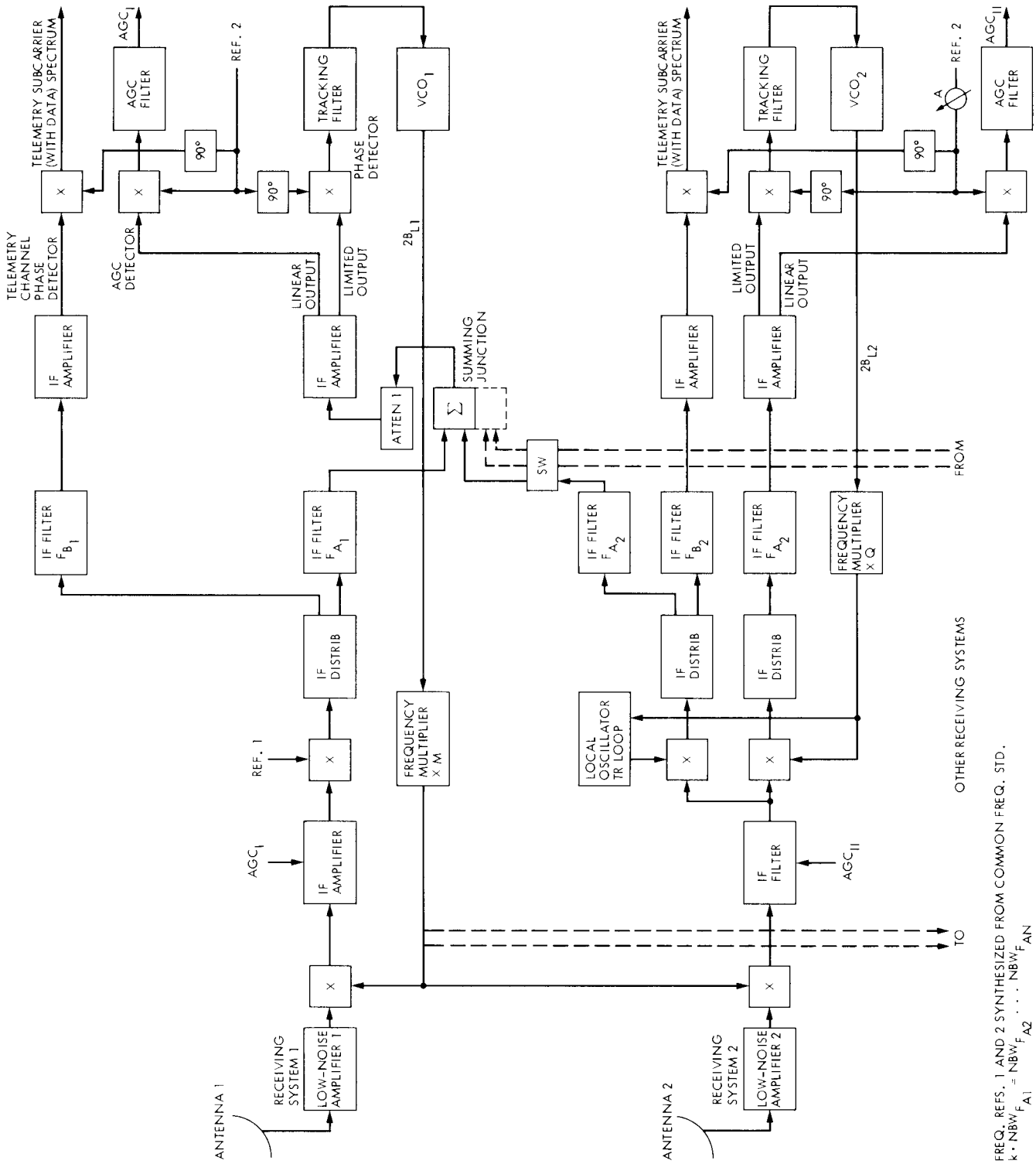

REF. 1 AND 2 SYNTHESIZED FROM COMMON FREQ. STD.
 $k \cdot NBW_{FA1} = NBW_{FA2} \dots NBW_{FAN}$

Fig. 2. Enhanced radio frequency carrier arraying with additional local oscillator filtering

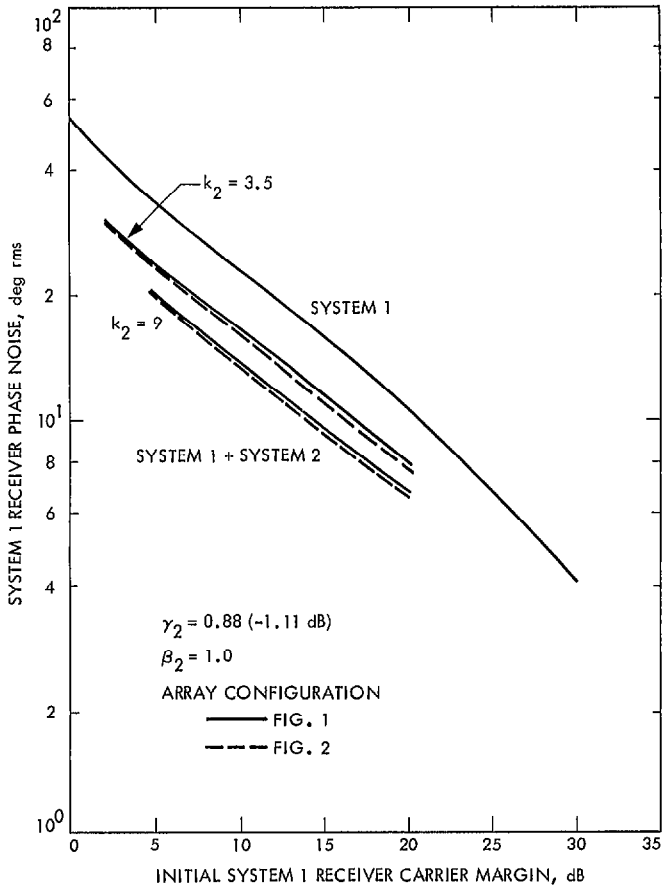

Fig. 3. The 34-m (high efficiency) receiver by itself and with enhanced RF carrier margin improvement. RF carrier tracking loop phase noise vs initial 34-m (high efficiency) receiver carrier margin. Two receiving systems arrayed: System 1 is the 34-m diameter high efficiency; System 2 is the 34-m diameter transmit/receive ($2B_{L_{o1}} = 12$ Hz).

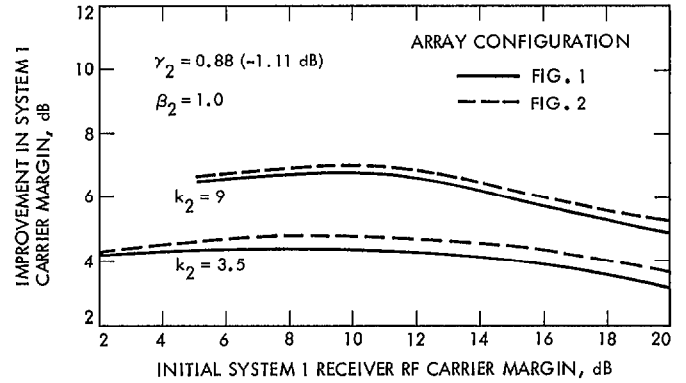

Fig. 4. Enhanced RF carrier margin improvement vs initial 34-m (high efficiency) receiver RF carrier margin. Two receiving systems arrayed: System 1 is the 34-m diameter high efficiency; System 2 is the 34-m diameter transmit/receive ($2B_{L_{o1}} = 12$ Hz).

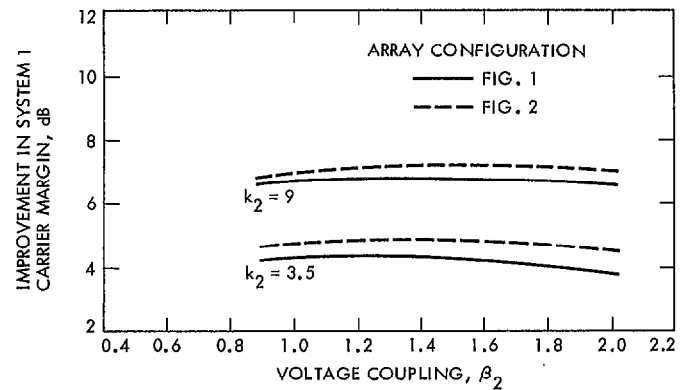

Fig. 5. The effect of summing junction voltage coupling on enhanced RF carrier margin improvement. Two receiving systems arrayed: System 1 is the 34-m diameter high efficiency; System 2 is the 34-m diameter transmit/receive ($2B_{L_{o1}} = 12$ Hz and $\gamma = 0.88$).

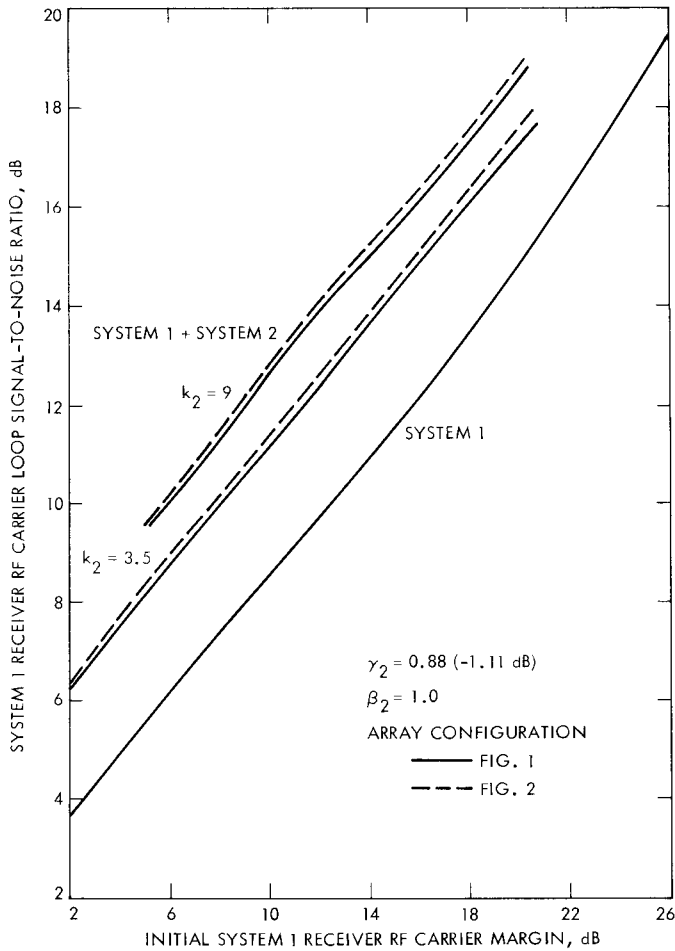

Fig. 6. The 34-m (high efficiency) receiver by itself and with enhanced RF carrier margin improvement. The RF carrier tracking loop signal-to-noise ratio vs initial 34-m (high efficiency) receiver carrier margin. Two receiving systems arrayed: System 1 is the 34-m diameter high efficiency; System 2 is the 34-m diameter transmit/receive ($2B_{L_{o1}} = 12 \text{ Hz}$).

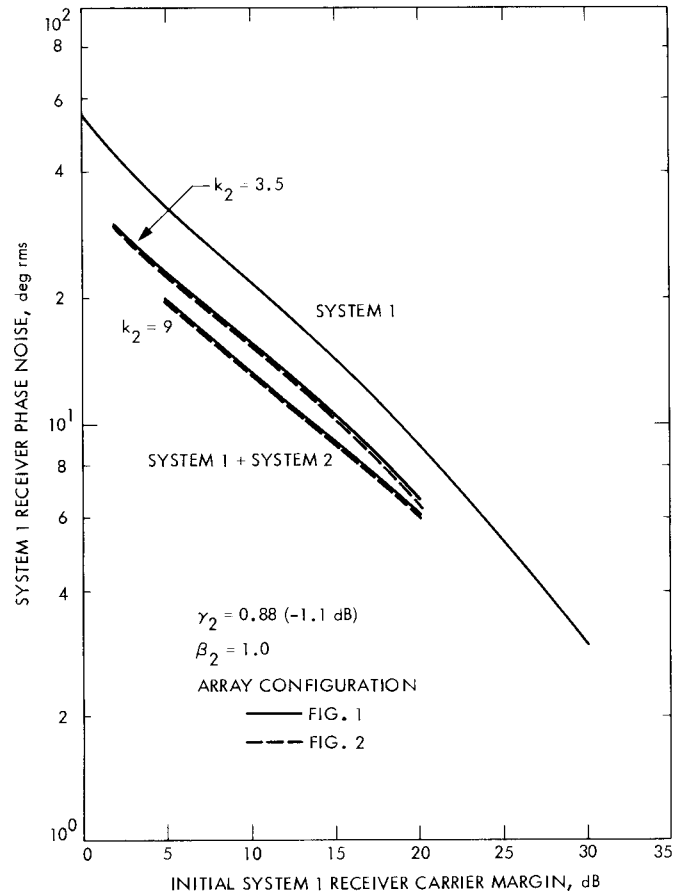

Fig. 7. The 34-m (high efficiency) receiver by itself and with enhanced RF carrier margin improvement. RF carrier tracking loop phase noise vs initial 34-m (high efficiency) receiver carrier margin. Two receiving systems arrayed: System 1 is the 34-m diameter high efficiency; System 2 is the 34-m diameter transmit/receive ($2B_{L_{o1}} = 48 \text{ Hz}$).

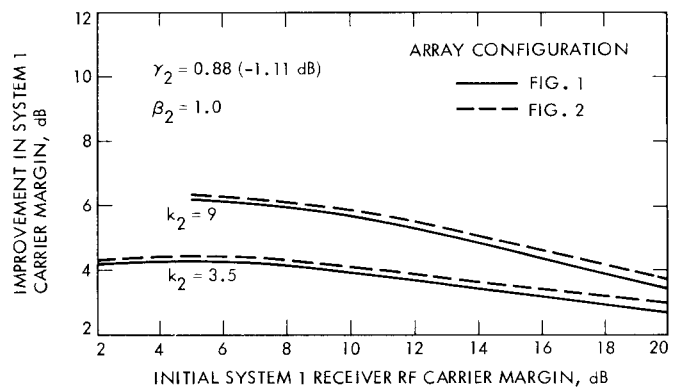

Fig. 8. Enhanced RF carrier margin improvement vs initial 34-m (high efficiency) receiver RF carrier margin. Two receiving systems arrayed: System 1 is the 34-m diameter high efficiency; System 2 is the 34-m diameter transmit/receive ($2B_{L_{o1}} = 48 \text{ Hz}$).

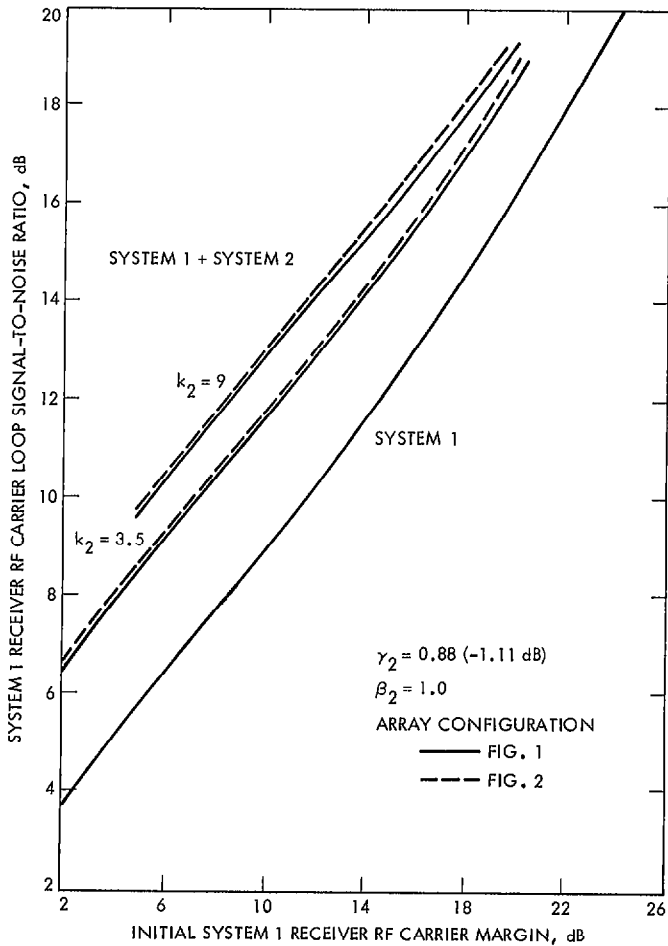

Fig. 9. The 34-m (high efficiency) receiver by itself and with enhanced RF carrier margin improvement. RF carrier tracking loop signal-to-noise ratio vs initial 34-m (high efficiency) receiver carrier margin ($2B_{L_{o1}} = 48$ Hz). Two receiving systems arrayed: System 1 is the 34-m diameter transmit/receive; System 2 is the 34-m diameter high efficiency; System 2 is the 34-m diameter transmit/receive.

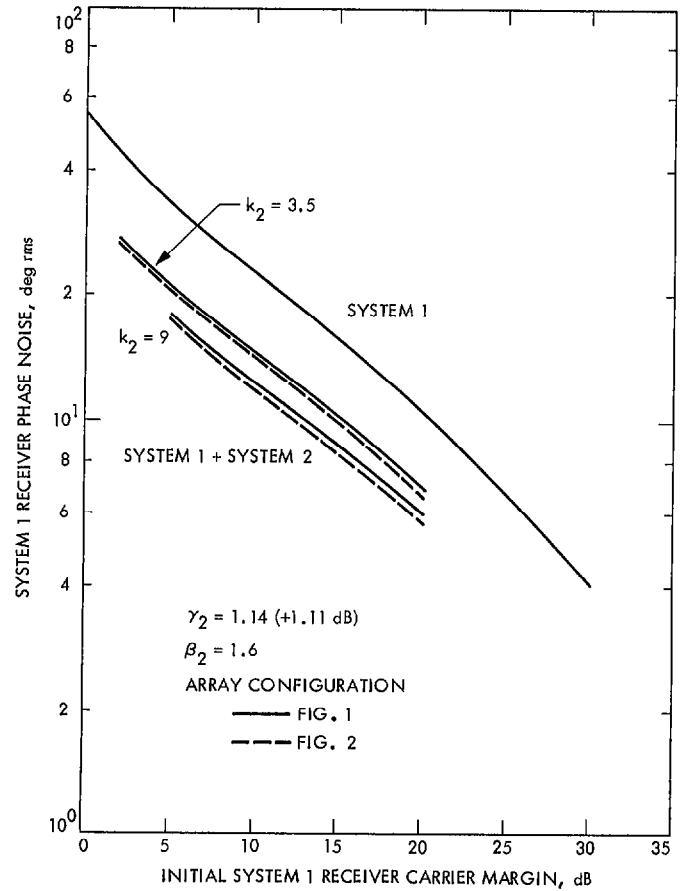

Fig. 10. The 34-m (transmit/receive) receiver by itself and with enhanced RF carrier margin improvement. RF carrier tracking loop phase noise vs initial 34-m (transmit/receive) receiver carrier margin. Two receiving systems arrayed: System 1 is the 34-m diameter transmit/receive; System 2 is the 34-m diameter high efficiency ($2B_{L_{o1}} = 12$ Hz).

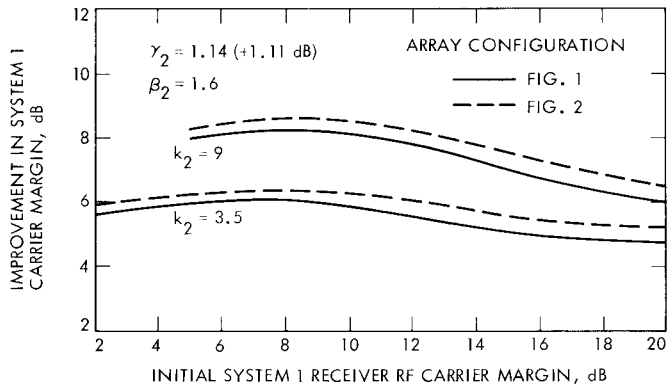

Fig. 11. Enhanced RF carrier margin improvement vs initial 34-m (transmit/receive) receiver RF carrier margin. Two receiving systems arrayed: System 1 is the 34-m diameter transmit/receive; System 2 is the 34-m diameter high efficiency ($2B_{L_{01}} = 12 \text{ Hz}$).

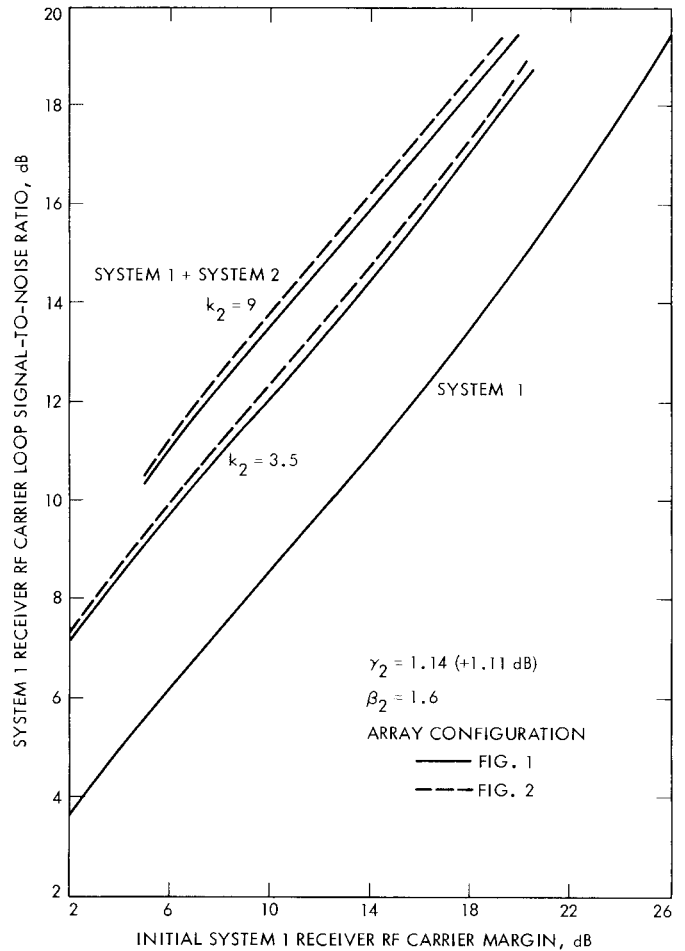

Fig. 13. The 34-m (transmit/receive) receiver by itself and with enhanced RF carrier margin improvement. RF carrier tracking loop signal-to-noise ratio vs initial 34-m (transmit/receive) receiver carrier margin ($2B_{L_{01}} = 12 \text{ Hz}$). Two receiving systems arrayed: System 1 is the 34-m transmit/receive; System 2 is the 34-m high efficiency.

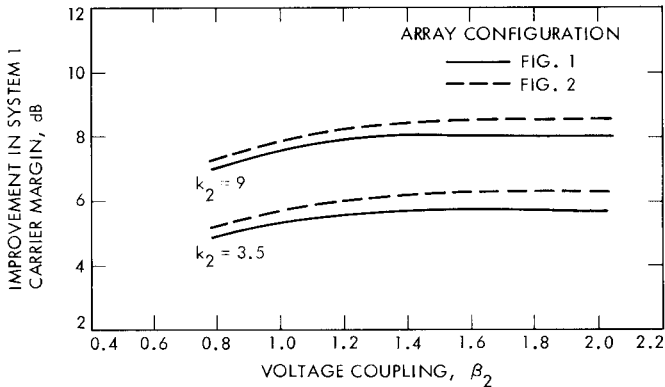

Fig. 12. The effect of summing junction voltage coupling on enhanced RF carrier margin improvement. Two receiving systems arrayed: System 1 is the 34-m diameter transmit/receive; System 2 is the 34-m diameter high efficiency ($2B_{L_{01}} = 12 \text{ Hz}$ and $\gamma_2 = 1.14$).

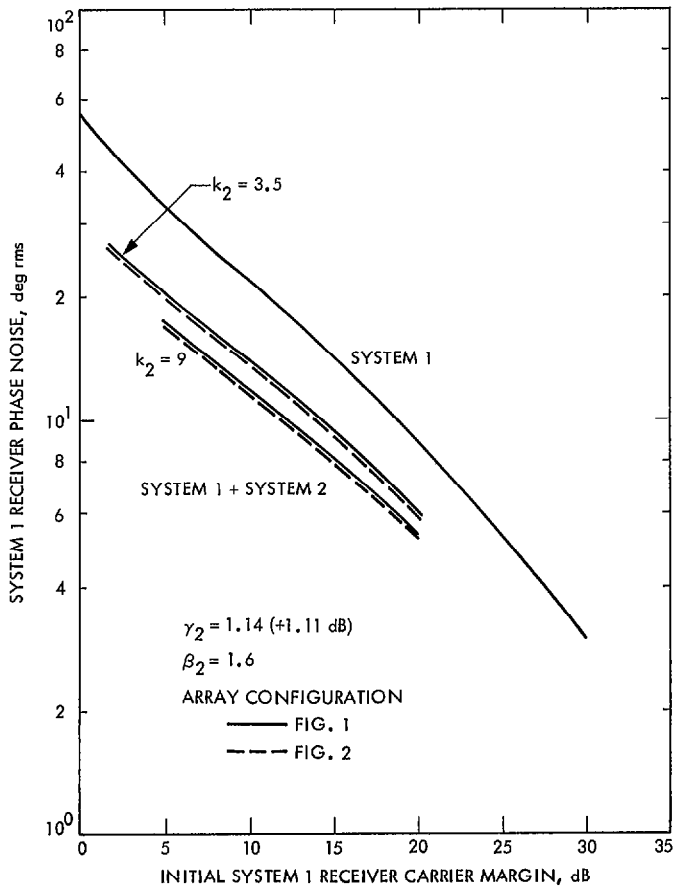

Fig. 14. The 34-m (transmit/receive) receiver by itself and with enhanced RF carrier margin improvement. RF carrier tracking loop phase noise vs initial 34-m (transmit/receive) receiver carrier margin. Two receiving systems arrayed: System 1 is the 34-m diameter transmit/receive; System 2 is the 34-m diameter high efficiency ($2B_{L_{o1}} = 48$ Hz).

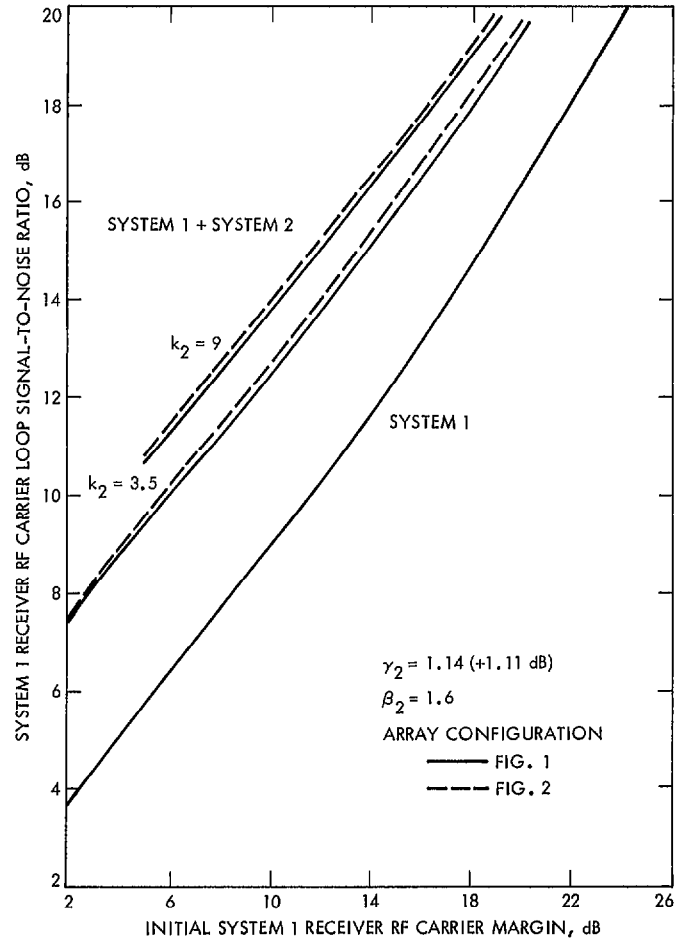

Fig. 16. The 34-m (transmit/receive) receiver by itself and with enhanced RF carrier margin improvement. RF carrier tracking loop signal-to-noise ratio vs initial 34-m (transmit/receiver) carrier margin ($2B_{L_{o1}} = 48$ Hz). Two receiving systems arrayed: System 1 is the 34-m transmit/receive; System 2 is the 34-m high efficiency.

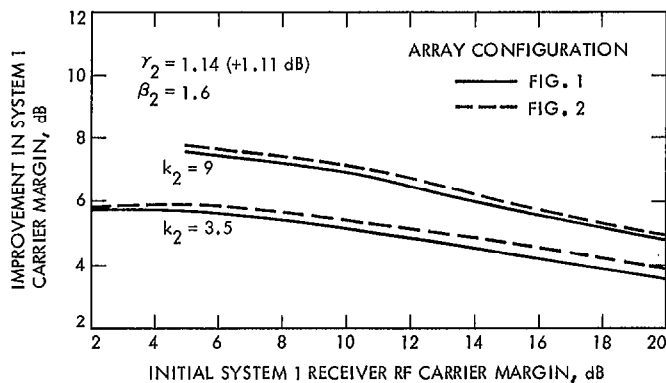

Fig. 15. Enhanced RF carrier margin improvement vs initial 34-m (transmit/receive) receiver RF carrier margin. Two receiving systems arrayed: System 1 is the 34-m diameter transmit/receive; System 2 is the 34-m diameter high efficiency ($2B_{L_{o1}} = 48$ Hz).

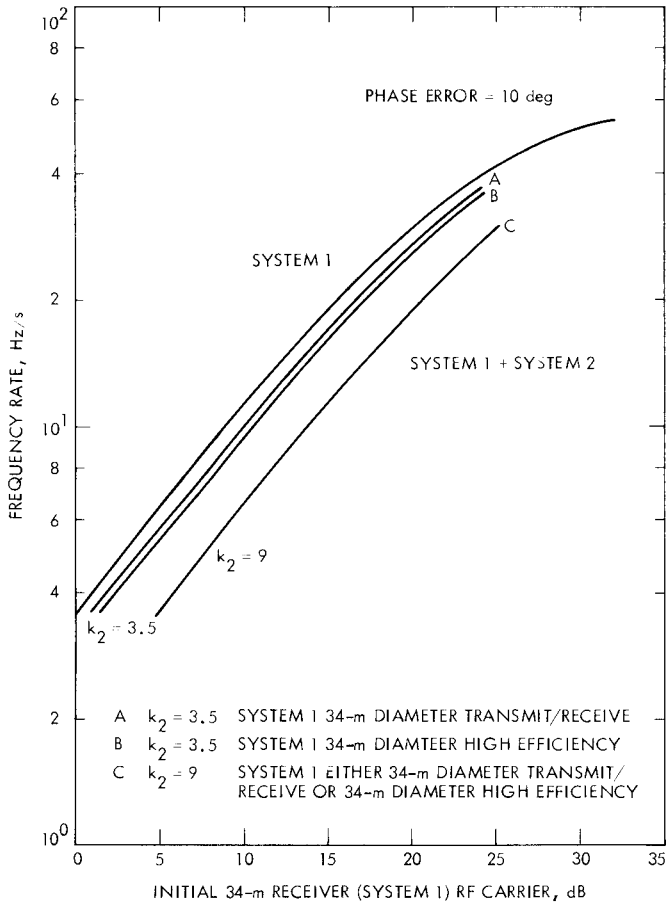

Fig. 17. The 34-m receiver by itself and with enhanced RF carrier margin improvement. Frequency rate capability vs initial 34-m receiver carrier margin. Two 34-m diameter antenna receiving systems arrayed ($2B_{L_{01}} = 12$ Hz).

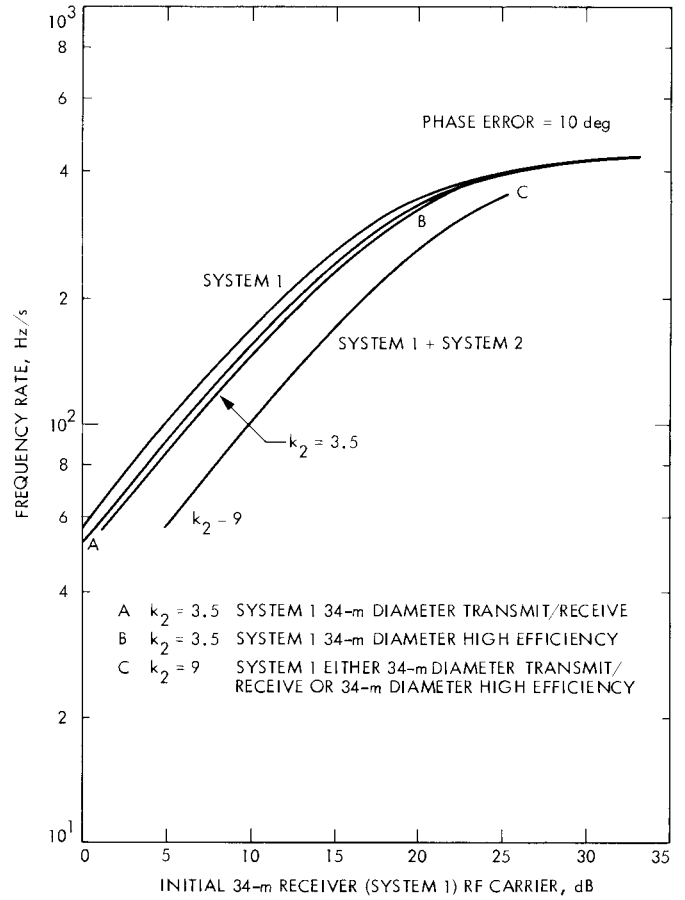

Fig. 18. The 34-m receiver by itself and with enhanced RF carrier margin improvement. Frequency rate capability vs initial 34-m receiver carrier margin. Two 34-m diameter antenna receiving systems arrayed ($2B_{L_{01}} = 48$ Hz).