

An Integral Sunshade for Optical Reception Antennas

E. L. Kerr

Communications Systems Research Section

Optical reception antennas (telescopes) must be capable of receiving communications even when the deep-space laser source is located within a small angle of the Sun (small solar elongation). Direct sunlight must not be allowed to shine on the primary reflector of an optical reception antenna, because too much light would be scattered into the signal detectors. A conventional sunshade that does not obstruct the antenna aperture would have to be about five times longer than its diameter in order to receive optical communications at a solar elongation of 12 degrees without interference. Such a long sunshade could not be accommodated within the dome of any existing large-aperture astronomical facility, and providing a new dome large enough would be prohibitively expensive. It is also desirable to reduce the amount of energy a space-based large-aperture optical reception facility would expend orienting a structure with such a sizable moment of inertia.

Since a large-aperture optical reception antenna will probably have a hexagonally segmented primary reflector, a sunshade consisting of hexagonal tubes can be mounted in alignment with the segmentation without producing any additional geometric obstruction. The tubes can be extended downward toward the primary reflector, until they reach the envelope of the focused beam to the secondary reflector. If the optical reception antenna is ground-based, the other ends of the tubes may be trimmed so that both the sunshade and the antenna will fit within a sphere whose diameter is only six-fifths the diameter of the primary reflector. If the segmentation involves four rings of hexagons with the central segment absent from the primary, then this sunshade is useful when solar elongations are as small as 12 degrees. Additional vanes can be inserted in the hexagonal tubes to permit operation at 6 or 3 degrees. The structure of the sunshade is very strong and can be used to support the secondary reflector instead of an independent support.

An analysis of the duration and recurrence of solar-conjunction communications outages (caused when a deep-space probe near an outer planet appears to be closer to the Sun than a given minimum solar elongation), and the design equations for the integral sunshade are appended.

I. The Need for Sunshading

Direct-detection optical communication at visible wavelengths from laser sources on deep-space probes requires that background interference be reduced to acceptable levels. Background from natural sources is usually incoherent and can be reduced substantially by narrowband filtering. Additional immunity to interference is achieved by sending an optical pulse only during one time slot of a series of time slots. After filtering, the remaining background level must be low enough to ensure an acceptably small probability that the background count in any empty time slot will be less than the background plus signal count in the signal time slot.

For optical communication to a deep-space probe near an inner planet, the background interference may be so high that heterodyne detection techniques are required. These reduce background by using a post-detection filter whose bandwidth is much narrower than the bandwidth of any pre-detection optical filter. The spatial coherence of the signal must be preserved, however, which certainly requires good optics and may preclude reception through the Earth's atmosphere.

In studies of typical missions to outer planets it has been shown that the background is acceptably small for direct-detection optical communications even when the sunlit planet fills a substantial field of view behind the spacecraft ([1], Appendix A). The sunlight to be excluded by the sunshade is then direct sunlight scattered within the reception antenna (telescope) when the planet is near conjunction, i.e., at small Sun-Earth-probe angles (small solar elongations).

A. Scattering from Rough Reflectors

Recommended plans for the Optical Reception Development Antenna [2] call for use of a hexagonally segmented primary reflector made up of light-weight, composite panels having a root-mean-square surface roughness of $2\mu\text{m}$.¹ It is anticipated that sunlight directly incident on such a surface would produce intolerable scattering into the detectors, no matter what internal sunshades were used. Therefore, a primary sunshade must be provided, capable of shading the primary reflector from direct sunlight whenever the antenna is used at more than the design minimum solar elongation.

B. Thermal Effects on Visible Reception Antennas

Sunlight will not heat sunshades to incandescence; therefore reradiation from the sunshade will not be a problem for visible reception (even though it is a problem for infrared and

millimeter-wave telescopes). Thermal distortion of the structure and convection currents or heat extraction difficulties are perennial problems deserving further study.

C. Communications Outages Near Solar Conjunction

The orbits of most of the planets lie close to the same plane, the plane of the ecliptic, which is the plane of the apparent path of the Sun through the sky and also the plane of the Earth's orbit. This means that the planets appear to approach the Sun as they are viewed from Earth. The times when the planets are close to the Sun are called conjunctions. The duration τ_d of a conjunction depends on the periods of revolution t of the Earth and T of the outer planet, and on the design minimum solar elongation E (the minimum solar elongation for communications is the maximum solar elongation of the conjunction that causes the communications outage). The period of recurrence τ_r of the conjunction depends on t and T .

Communications with a probe on a mission to an outer planet will be blocked whenever the planet appears to come too close to the Sun, as in Fig. 1. Table 1 shows the duration of outages for various limiting solar elongations, and the period of recurrence, for the outer planets. The formulas on which the table was based are derived in Appendix A.

The inclinations i of the orbital planes of each of the outer planets with respect to the Earth's orbital plane are also given in Table 1. The line of intersection of the orbital planes of a pair of planets is called the line of nodes. Only Pluto's orbit is highly inclined. This means that Pluto approaches a close conjunction only during the times when the Earth and Pluto are close to opposite ends of their line of nodes. At other times Pluto appears to pass at a variable angle (as much as 17 degrees) north or south of the Sun. The other outer planets move in orbital planes too close to the Earth's to help much in relieving the communications interference encountered near solar conjunction.

II. Disadvantages of Conventional Sunshades

The usual primary lightshade of a telescope is an internally blackened tube extending from the primary reflector to a short distance beyond the primary focus. This provides shading for the secondary reflector also, in a Cassegrain or Newtonian arrangement. Other internal baffles may be added. If a sunshade is needed, it is usually added as an extension of the primary lightshade beyond the primary focus. Sometimes this extension is cut down to a sun visor in order to reduce weight, though that requires the operation of orienting the telescope axially, relative to the Sun.

¹P. N. Swanson, *A Lightweight Low Cost Large Deployable Reflector (LDR)*, JPL Publication D-2283 (internal document), Jet Propulsion Laboratory, Pasadena, California, pp. 5-1-5-6, June 1985.

The chief disadvantage of an extended primary lightshade is the length required in order to look at targets when the solar elongation is small, without allowing light to strike the primary reflector. The length required is $D \cot E$. If the telescope diameter D is 10 m and $E = 12$ degrees, the length is 47 m, which makes a very unwieldy telescope.

A series of slats or flat plates may be inserted within the tube, such that the normal to the plates is perpendicular to the line of sight. If the slats divide the diameter into n spaces of equal thickness between them, then the overall required sunshade length is divided by n . The number n cannot be made very large, however, for two reasons. First, the slats must be made of some material having a finite thickness, and the sunshade cannot be kept in perfect alignment with the line of sight. This means that the slats will obstruct the view to some extent, contributing some fraction to the opacity of the telescope. Second, the slats will introduce additional diffraction and spread the image of the deep-space laser source. The field stop will then have to be opened to capture a reasonable fraction of the incoming signal power. If a planet or another extended object is in the background, the background level will increase as the field stop is opened and the performance of the communications link will be degraded.

A. End-Mounted Sunshades

The largest telescopes, used for astronomy, do not have sunshades associated with them. Astronomers use the Earth as a natural sunshade by doing their observing at night. This is necessary because the natural objects they look at emit incoherent radiation which is too faint to be separated from the scattering in the daytime blue sky.

The dome is the most expensive component of an observatory building, and the cost increases faster than the square of the diameter. (The log-log graph in Fig. 2 has a best-fitting slope of 2.02 for standard, electrically-driven, hemispherical domes from 3 to 11 m in diameter. The 37-m Keck dome is custom-made, more than hemispherical, and has special drives and sensors for precise positioning. The slope from the largest standard dome to the Keck dome is 3.81.) For this reason, among others, the dome is usually made only large enough to clear the swing sphere swept out by the motion of the telescope.

1. Ground-based antennas. If an astronomical observatory with a large-diameter telescope were converted or rented for use as a ground-based optical reception station, an end-mounted sunshade of a reasonable length could not be accommodated within the dome, for the reasons stated above.

2. Space-based antennas. A space-based optical reception antenna could conceivably be sunshaded by a tube (or visor or

even a flat plate) whose length was about five times the diameter of the antenna. Ingenious methods could be devised to transport such a structure to space, erect, and assemble it. However, the moment of inertia would be very large. A great deal of energy would be expended in orienting the telescope and sunshade while tracking a deep-space probe.

B. Externally Mounted Sunshades for Ground-Based Reception

Since most large telescopes are protected by a dome, it would be possible to mount a long tube externally on the dome. Alignment of the tube with the telescope is necessary but is not required to be very precise. A small computer could easily control the azimuth of the dome and the elevation angle of the sunshade as well as the azimuth and elevation of the telescope, when tracking an object and compensating for the rotation of the Earth.

However, most observatory sites are on mountain peaks where they are subject to occasional high winds. Table Mountain Observatory, for example, reports clocking winds at 90 m/sec (200 mph), which their domes survive. An externally mounted sunshade would add considerable wind load to the dome. The dome would have to be strengthened for operation in moderate winds, and the sunshade would have to be stowed securely whenever high winds or inclement weather was anticipated.

III. Solution: The Integral Sunshade

An integral sunshade for optical reception antennas is proposed to overcome the disadvantages detailed above. Figures 3 and 4 are photographs of a glue-and-paper model of the integral sunshade. The sunshade consists of a bundle of closely packed hexagonal tubes, aligned with the antenna line of sight, forming a structure that supports the secondary reflector. (This makes the sunshade an integral part of the telescope structure.) The outer edges of the outermost tubes extend around the primary reflector and form the primary sunshade. Inside, the tubes are cut off just short enough to provide clearance for the focused beam to the secondary reflector. The opposite ends are trimmed in the form of a spherical cap, to fit within the swing sphere of the telescope.

A plan view of the reflector is shown in Fig. 5. The axial hexagons are those that straddle the x -axis. The central hexagon is numbered (0,0). The other hexagons are numbered first by their ring number (starting with the innermost) and then by their sequence number within the ring (starting with the axial hexagon). The numbered hexagons all have different surface figures in order to fit together into a parabolic reflector. The points of individual hexagons have been lettered A, B, C, D, E,

and F, counterclockwise starting with the point closest to the 60-degree line. This lettering is illustrated for hexagons (1,1) and (3,3).

The other ring hexagons are symmetrical with respect to rotations of 60 degrees. The axial hexagon on the outermost ring, (4,1) in Fig. 5, is called a corner hexagon.

Figure 6 shows the integral sunshade concept as it would be for a Cassegrain optical reception antenna having a 10-m, $f/0.5$, hexagonally segmented, four-ring, primary reflector. An x - z cross-section and a y - z cross-section are shown, each covering only the positive half of the x - or y -axis. The reflector lies at the bottom of, and is tangent to, a 12-m-diameter swing sphere. The secondary reflector is the same size as the absent central hexagonal panel of the primary reflector.

Another baffle surrounds the hole in the primary left by the absent central hexagon. This baffle consists of the frustum of a six-sided pyramid cut off by the intersection of two planes to form each edge. One plane is determined by the edge of the central hexagon and the primary focal point. The other is determined by the edge of the secondary reflector and the secondary focal point. The pyramid is illustrated in each cross-section of Fig. 6 by a line from the primary reflector slanting inward.

Within the pyramid is a conical (or cylindrical) baffle designed to capture rays that enter the pyramid after passing through the innermost ring tube. This baffle is illustrated in each cross-section of Fig. 6 by a line from the center of the primary reflector slanting outward.

A. Design Premises

1. Sunlight may not be allowed to shine anywhere on the primary reflector. Premise 1 could be violated, of course, by looking at a deep-space probe at less than the allowed solar elongation. Sunlight would not flood the entire primary until the solar elongation was equal to half the solar subtense. A small amount of sunlight scattering from the primary might be tolerable, depending on the parameters of the optical communications link. However, Premise 1 is used to define the minimum solar elongation for normal operation.

2. A ray of sunlight is considered to be stopped when incident, however obliquely, on the blackened surface of any part of the sunshade. Premise 2 does not require the existence of a perfect absorber with no forward scattering. It only means that the absorption is adequate to reduce the interference caused by the remaining forward-scattered sunlight to tolerable levels.

3. The sunshade parts and reflecting surfaces are considered to be infinitesimally thin. Premise 3 actually renders the design conservative. In practice it is expected that there will be gaps of about 2 cm or so between the panels of the primary reflector. The walls of the hexagonal tubes will not have to be nearly so thick to form a very strong structure. The absorption of obliquely incident rays on their surfaces may therefore be improved by adding ridges or ring baffles consisting of thin plates cut to fit perpendicularly within the tubes, having a hexagonal hole punched in them the same size as the reflecting panel below. A light ray incident on the tube wall just above such a ring would experience two geometrical reflections, one from the tube wall followed by one from the ring baffle, such that the ray would actually be reflected back parallel to itself, as illustrated in Fig. 7.

Ring baffles effectively reduce the chords across the tubes without introducing any additional geometrical obscuration of the telescope aperture beyond that produced by the segmentation. Reduction of the chords without changing the lengths of the tubes means that the sunshade could be used at solar elongations slightly less than the minimum.

4. The truss supporting the primary reflector and the optics behind it can all be fitted in the space between the primary reflector and the swing sphere. If Premise 4 cannot be fulfilled in fact, the dome will have to be made with a somewhat larger clearance.

The design equations are set forth in Appendix B.

B. Design for Operation Within a Minimal Dome

During the initial conception of this design it was observed that the top ends of the hexagonal tubes follow a curve that parallels, to some extent, the cone of the focused beam from the primary to the secondary. For an $f/0.5$ primary the parallelism is good when the diameter of the swing sphere is six-fifths of the diameter of the primary. This allows operation within a dome that fits very closely over the optical reception antenna. Such a dome and sunshaded telescope are illustrated in Fig. 8. The dome opening is far larger than that of conventional domes with meridional shutters, however, and the dome must be much more than hemispherical if the telescope is to be able to look horizontally or down to some minimal elevation angle.

The two shortest sets of tubes are then the tubes on the innermost ring, and those on the corners of the outermost ring. Rays entering along the longest chords within the innermost tubes are stopped by the pyramid, however. The minimum solar elongation is equal to the arcsine of the ratio of the

longest chord to the shortest distance through the corner tube on the outermost ring from top to bottom perimeters. The longest chord is between the points of the tube. The shortest distance goes from either of the top outermost points to the opposite bottom inner point.

In the design shown in Figs. 3 through 6 the minimum solar elongation E is 12.44 degrees. Allowing for ring baffles 1 cm wide reduces E to 11.96 degrees.

The minimum solar elongation may be cut approximately in half by inserting a set of plates or vanes between the points of each tube, so the cross section resembles an asterisk inscribed within a hexagon (Fig. 9a). The plates would run the length of the tube, and would be cut off at the ends to fit the primary focused beam and the swing sphere, just as the tubes are. This effectively subdivides the hexagonally segmented aperture into equilateral triangles. This time additional obscuration and diffraction are introduced.

Reduction of the minimum solar elongation to one quarter can be accomplished by subdividing each of the equilateral triangles again with plates. The cross section resembles a six-pointed star superimposed over the asterisk and inscribed within a hexagon (Fig. 9b). This structure would be stable without the circumscribing hexagon (unlike the asterisk structure). The tubes could be designed with channels running the length of each point, and the six-point-star-and-asterisk vanes could be inserted in each tube whenever it was necessary to track an object at close solar conjunction. The vanes could be removed whenever operations did not require looking closer than 12 degrees of the Sun to eliminate the obscuration and diffraction the vanes cause.

C. Application to a Space-Based Reception Antenna

A space-based antenna would not have to swing within a prescribed sphere. However, the integral sunshade has a moment of inertia that is considerably smaller than that of an open tube providing similar sunshading, and the center of gravity is much closer to the primary focal point. These factors favor use of the integral sunshade for space-based optical reception antennas operating in the visible region of the spectrum.

The structure of the sunshade is very strong and rigid. It may be used to mount the secondary reflector at a fixed distance from the primary. The mass and added diffraction of a secondary-reflector support spider are eliminated.

D. Summary of Design Advantages

A very compact, manageable sunshade is provided. No geometrical obscuration not introduced already by segmentation

of the primary reflector is added. The amount of diffraction added by the sunshade is very small.

The swing sphere for the entire system is only slightly larger than the sphere needed to swing the primary reflector. No wind loads are added to the dome. Dismounting and stowing an external sunshade for anticipated inclement weather are not required.

The center of the swing sphere is placed very close to the primary focal point. (A small adjustment of the focal length of the primary reflector would make the two points coincide, if that were desirable.) The design provides a rigid structure to support the secondary reflector above the primary. The mass and added diffraction of a secondary support spider are eliminated.

E. Possible Extensions of the Design

The minimum solar elongation is set by skew rays through the tubes on the corners of the outermost ring. It is possible to reduce the minimum solar elongation by adding some small additional baffles.

One method would simply cap a portion of the outer top edge of the corner tube whenever the telescope is used at a small solar elongation. The area of the effective aperture would be reduced only slightly, and a somewhat smaller solar elongation would be allowed.

Another method would add some short vertical baffles arranged along radial lines at the inner points of the bottoms of the corner tubes on the outer ring. The entering collimated beam from the deep-space probe and the focused beam to the secondary reflector would be obstructed by these vertical radial baffles only to the extent of their finite thickness. However, they could be made long enough to come close to the surface of the primary reflector (to within a suitable clearance), and could intercept the skew rays that had previously limited the minimum solar elongation. The minimum solar elongation might therefore be reduced to a new limit imposed by skew rays in another set of tubes, either the nearest neighbors of the corner tubes on the outermost ring, or the tubes that form the next-to-innermost ring.

F. Areas Requiring Further Study

1. **Use of radial baffles within the focused beam region between reflectors.** Small radial extensions of the baffles on the outermost-ring corner tubes have been mentioned already.

Inspection of Fig. 5 shows that some of the segmentation lines are radial, on the odd-numbered rings beginning with the

innermost. Since the integral sunshade forms a very strong structure, and radial plates introduce an additional geometrical obstruction proportional only to their thickness, a designer might consider extending the radial walls of the tubes downwards to tie together the integral sunshade and the primary reflector support truss. Very little additional sunshading would be provided, but a more rigid overall structure would be obtained. Thermal analysis would have to show that the advantage in rigidity would not be offset by the thermal distortions caused by nonuniform heating of the sunshade.

2. Thermal problems to be overcome. Absorption heating will occur on one side only of the tubes, with the depth of penetration dependent on the location of the tubes relative to the Sun. Due allowance must be made for thermal distortion of the structure, and possible dislocation of the secondary reflector.

a. Ground-based antennas. Convection currents within the tubes will arise if a large temperature difference exists between opposite walls. These currents produce fluctuations in the density and refractive index of the air, and would blur the image of the deep-space laser source at the focal point of the system. The threshold for the onset of convection, i.e., the ratio of the temperature difference between opposite walls to the absolute temperature, is inversely proportional to the cube of the distance between the walls [3]. The walls must therefore be highly thermally conducting, in order to reduce the temperature difference between opposite walls within a tube as much as possible. The central tube can be left open at the top, with a thermal shield over the secondary reflector at the bottom, in order to ensure uniform heating of its walls. This also suggests that the outer surfaces of the sunshade should be blackened, contrary to the normal practice of making the primary sunshade white on the outside.

The tubes on the side closest to the Sun will be penetrated to a greater depth, and through a larger projected aperture, than the tubes on the side farthest from the Sun. When the deep-space probe is seen above the Sun this situation can lead to gravity-driven circulation of air that will enter the lower tubes, pass between the reflectors, and exit through the upper tubes. As long as the flow is laminar the blurring of the image will be minimal. However, the dynamics of this process require study.

Forced outward convection of filtered air through all the tubes may be capable of providing necessary cooling, preventing unstable or turbulent convection, and keeping the optics clean.

b. Space-based antennas. Lack of convection will eliminate blurring of the optical image but may require introduction of heat pipes or other means of heat extraction.

3. Use of the sunshade instead of a dome. Microwave radio antennas are often used without domes. It may be possible to provide tube caps and weatherization that would eliminate the need for a dome over the optical reception antenna, at a substantial savings in cost.

4. Mass reduction and deployability of a space-based integral sunshade. Deployment of a low-mass integral sunshade in space represents a solvable construction challenge, especially if the integral sunshade is used as proposed to support the secondary reflector in relation to the primary reflector instead of a support spider.

IV. Conclusions and Recommendations

A novel kind of sunshade has been proposed for large-aperture hexagonally segmented optical reception antennas, to permit optical communication even when the deep-space laser source is as close to the Sun as 12 degrees. Inserts in the tubes of the sunshade would permit operations at solar elongations as small as 6 or 3 degrees, at a slight reduction in effective aperture area and a small increase in diffraction spreading of the source image.

The compactness of the sunshade effects a substantial cost savings when the optical reception antenna is ground-based and housed under a dome. The inner diameter of the dome can be almost as small as six-fifths of the aperture diameter. A space-based optical reception antenna would use much less energy to orient this sunshade than it would orienting a conventional sunshade of comparable functionality, and the mass and added diffraction of a secondary-reflector support spider are eliminated.

A few design issues remain for investigation, such as the thermal distortion, convection currents with ground-based antennas, and heat extraction for space-based antennas.

References

- [1] J. R. Lesh and D. L. Robinson, "A Cost-Performance Model for Ground-Based Optical Communications Receiving Telescopes," *TDA Progress Report 42-87*, vol. July-September 1986, Jet Propulsion Laboratory, Pasadena, California, pp. 56-64, November 15, 1986.
- [2] E. L. Kerr, "Strawman Optical Reception Development Antenna (SORDA)," *TDA Progress Report 42-93*, vol. January-March 1988, Jet Propulsion Laboratory, Pasadena, California, pp. 97-110, May 15, 1988.
- [3] J. W. Strutt, "On Convection Currents in a Horizontal Layer of Fluid, When the Higher Temperature is on the Under Side," *Philosophical Magazine*, vol. 32, pp. 529-546, 1916. Reprinted in *Scientific Papers, Cambridge, 1920*, New York: Dover Publications, vol. 6, pp. 432-446, 1964.

Table 1. Recurrence and duration of solar conjunctions

Planet	T , sec	τ_p , yr, d	Elongation, deg				i , deg
			12	6	3	1	
			τ_d , d	τ_d , d	τ_d , d	τ_d , d	
Mars	59355300	2 49	86	43	22	7	1.850
Jupiter	374320000	1 34	32	16	8	3	1.309
Saturn	929604000	1 13	28	14	7	2	2.493
Uranus	2651140000	1 4	26	13	6	2	0.773
Neptune	5200270000	1 2	25	13	6	2	1.779
Pluto	7837350000	1 1	25	13	6	2	17.146

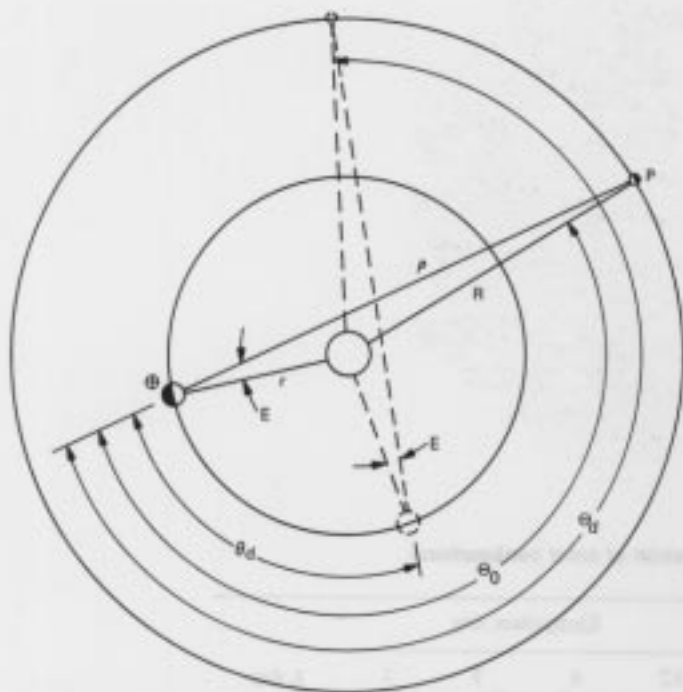

Fig. 1. Configuration of the Earth (\oplus) and an outer planet P when approaching (solid lines) and leaving (broken lines) solar conjunction within solar elongation E .

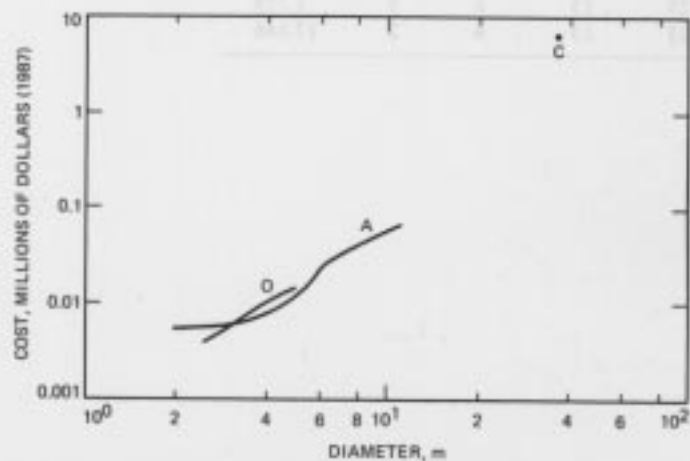

Fig. 2. Logarithm of dome cost versus dome diameter. Data supplied by manufacturers: A = Ash-Dome, C = Coast Steel, O = Observa-Dome Laboratories.

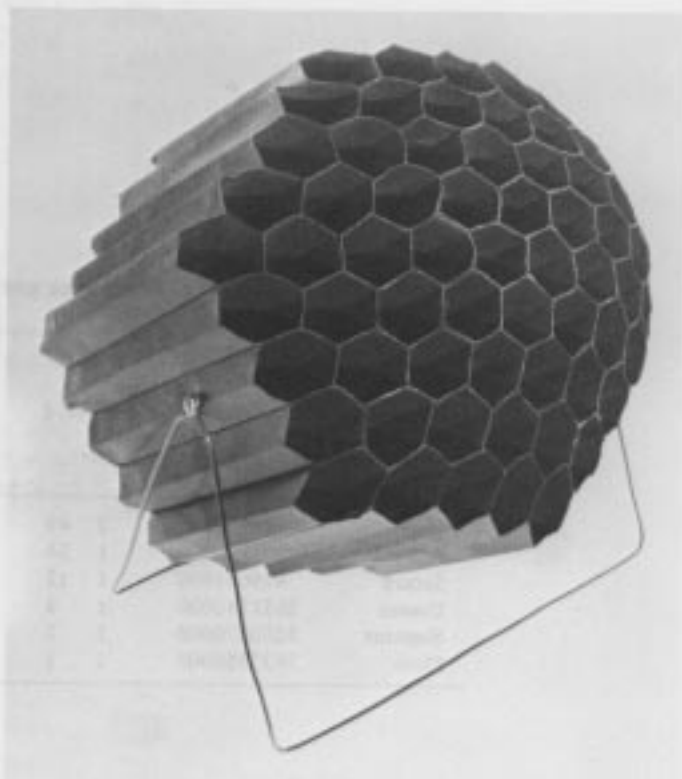

Fig. 3. Overview of a glue-and paper model of an integral sunshade. The telescope looks through the sunshade from behind and below it, in this view. The hexagonal tubes are trimmed to a spherical shape.

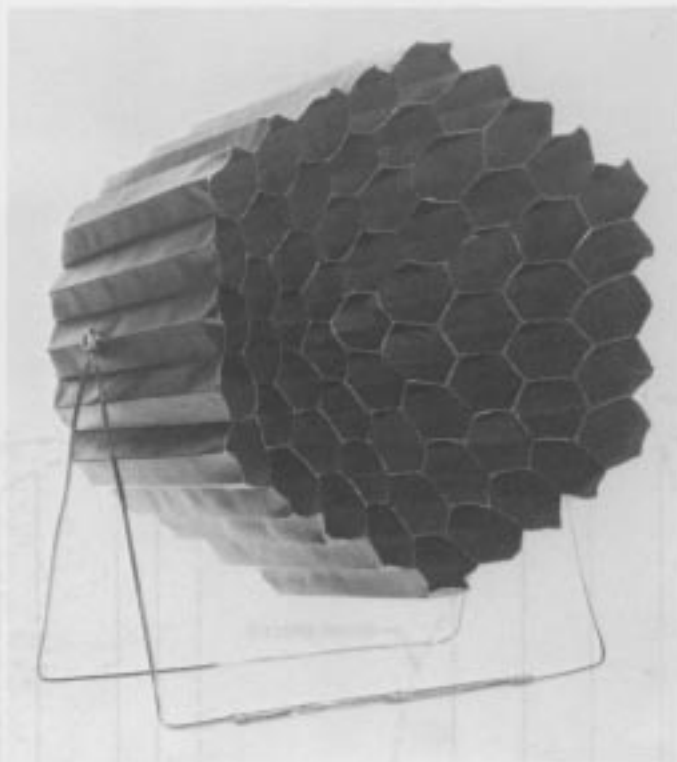

Fig. 4. Underside view of an integral sunshade model. The hexagonal tubes are trimmed to form a six-sided pyramid, with the secondary reflector to be mounted at the apex and the primary reflector at the base.

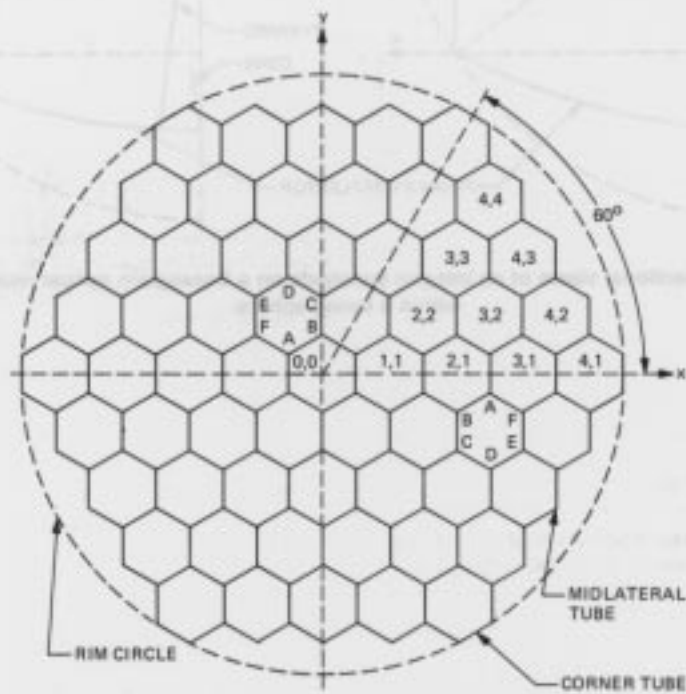

Fig. 5. Plan view of a hexagonally segmented reflector.

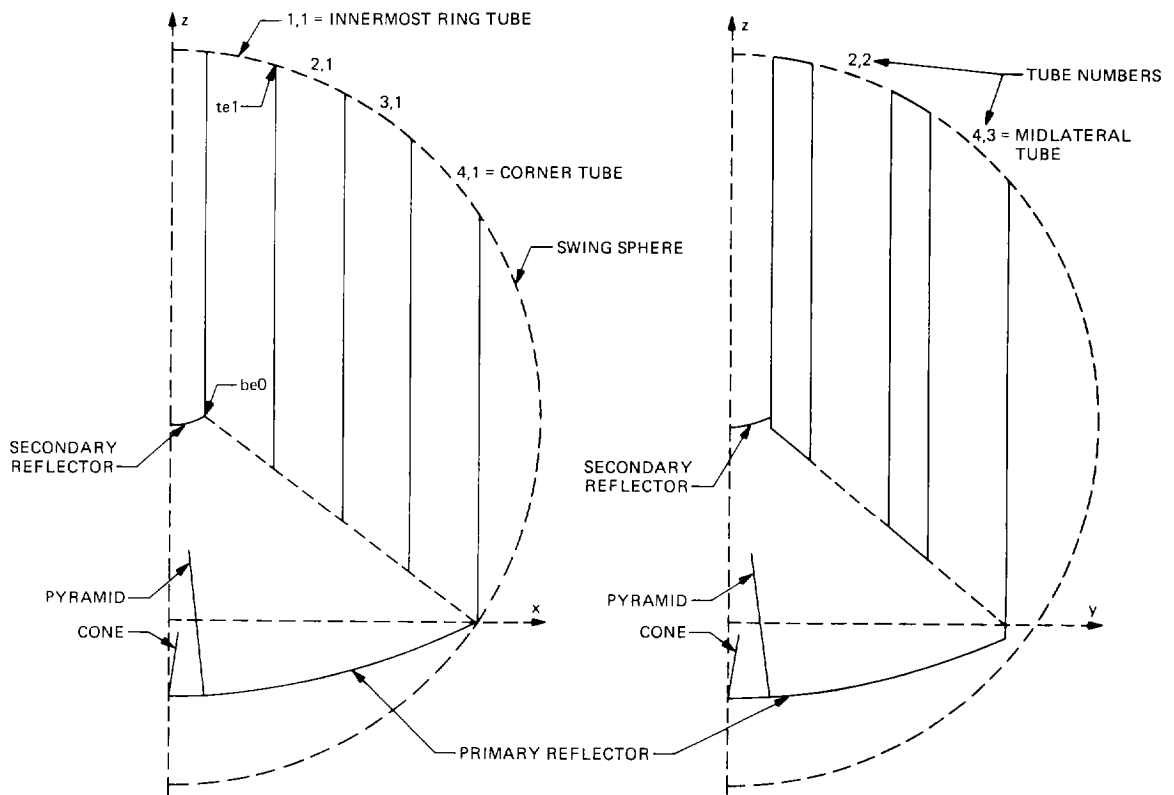

Fig. 6. Cross-sectional views of an integral sunshade on a Cassegrain optical reception antenna within a swing sphere.

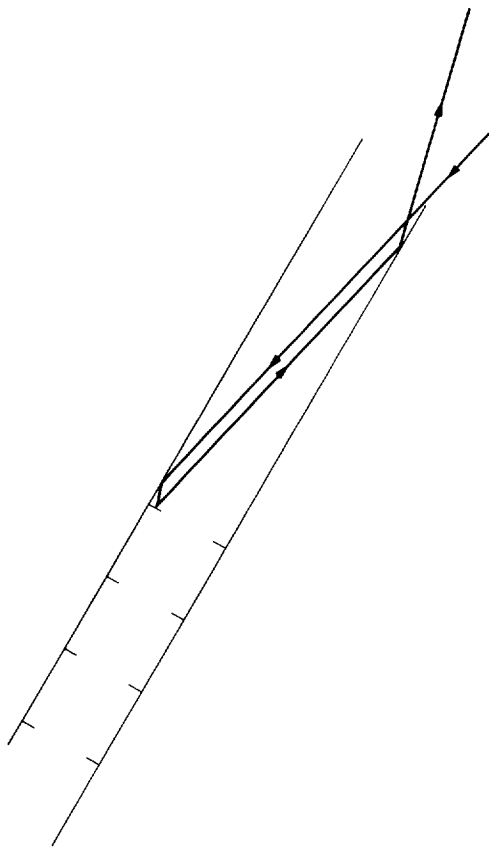

Fig. 7. Geometrical reflection of rays from a tube wall and ring baffles.

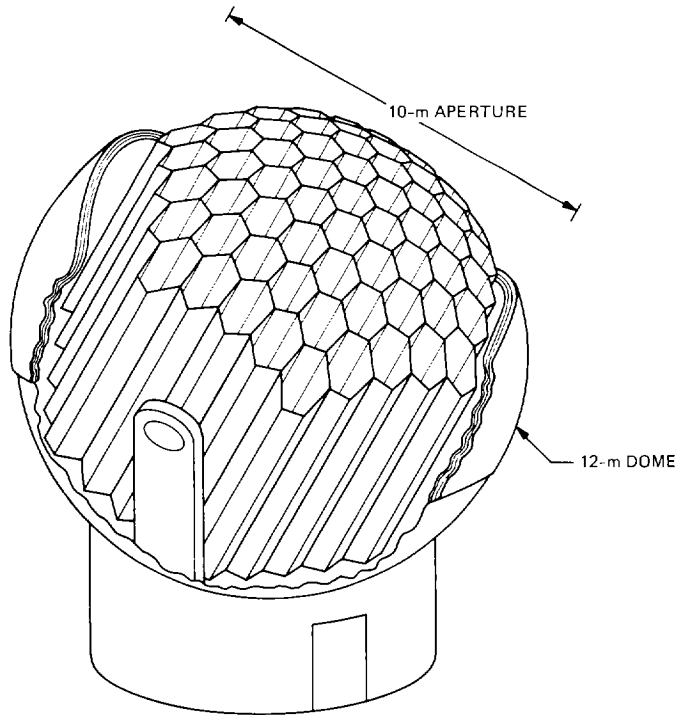

Fig. 8. An optical reception antenna and integral sunshade fitting within a spherical dome whose diameter is six-fifths the aperture diameter.

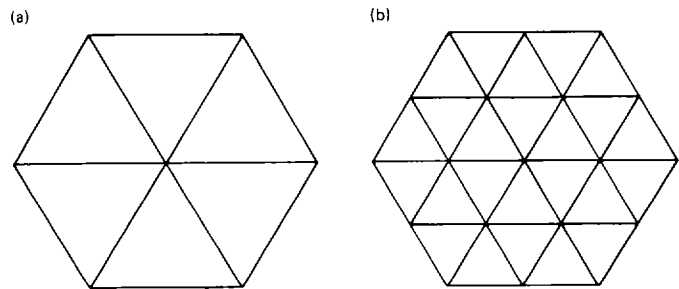

Fig. 9. Cross sections of (a) asterisk vanes within a hexagonal tube and (b) six-point-star vanes superimposed over asterisk vanes.

Appendix A

Duration and Recurrence of Outer-Planet Conjunctions

The orbits of the Earth and an outer planet P of the solar system are shown in Fig. 1 as viewed from above the north pole of the Sun. The respective periods of revolution t and T are related to the respective orbital semimajor diameters r and R by Kepler's law, $r^3/t^2 = R^3/T^2$, which shows that the outer planet moves at a slower angular rate $2\pi/T$ than the Earth's angular rate $2\pi/t$. The zero of angular measurement is designated as the Earth's position at the time that the outer planet is seen from Earth at an elongation angle E east of the Sun, when the planet is approaching conjunction. The analysis will be simplified by approximating the orbits with circles lying in the same plane and concentric on the Sun. The distance between the Earth and the outer planet is ρ , and the angular position of the outer planet is Θ_0 . Trigonometric relationships for the solid-line Earth-Sun-outer-planet triangle yield

$$\frac{\sin(2\pi - \Theta_0)}{\rho} = \frac{\sin E}{R}, \quad \rho^2 = r^2 + R^2 - 2rR \cos(2\pi - \Theta_0)$$

Squaring the first relationship, substituting for ρ^2 from the second, and replacing $\sin^2(2\pi - \Theta_0)$ with $1 - \cos^2(2\pi - \Theta_0)$ leads to a quadratic equation whose solution is

$$\Theta_0 = 2\pi - \cos^{-1} \left[\frac{r}{R} \sin^2 E \pm \cos E \sqrt{1 - \frac{r^2}{R^2} \sin^2 E} \right]$$

The lower sign corresponds to the solution sought. The upper sign leads to a solution that becomes degenerate if one considers conjunction of a planet in the same orbit as the Earth, so $R = r$. (The upper-sign solution would correspond to a position coincident with the Earth, and the ratio $(\sin E)/R$ would be equal to the ambiguous form $0/0$.) The ratio r/R may be replaced with $(t/T)^{2/3}$ in order to work only with the planetary revolution periods.

The orbital position of the Earth at any time τ is $\theta = 2\pi\tau/t$, and that of the outer planet is $\Theta = \Theta_0 + 2\pi\tau/T$. At the time τ_d when the outer planet has passed conjunction and is seen at an angle E west of the Sun (i.e., at the end of the time that the outer planet is seen within an elongation E of the Sun), the Earth has reached the position θ_d , the outer planet has reached the position Θ_d , and the configuration is represented by the broken-line triangle. The solid- and broken-line triangles are congruent since the radii and the elongation angles are equal, so the two obtuse angles are equal,

$$2\pi - \Theta_0 = \Theta_d - \theta_d = \Theta_0 + 2\pi\tau_d \left(\frac{1}{T} - \frac{1}{t} \right)$$

The solution for the duration is

$$\tau_d = \frac{\left(\frac{\Theta_0}{\pi} - 1 \right)}{\left(\frac{1}{t} - \frac{1}{T} \right)}$$

The next occurrence of an epoch of conjunction begins at τ_r , the first time the difference between the orbital positions $(\Theta - \theta)$ modulo 2π is again equal to the original difference Θ_0 . The outer planet moves more slowly so the difference becomes negative and 2π will have to be added. This gives

$$\Theta_0 + \frac{2\pi\tau_r}{T} - \frac{2\pi\tau_r}{t} + 2\pi = \Theta_0$$

$$\tau_r = \frac{1}{\left(\frac{1}{t} - \frac{1}{T} \right)}$$

Appendix B

Design Equations

The integral sunshade for an optical reception antenna was designed on the basis of a parameterized model of the antenna. The antenna is assumed to consist of a parabolic primary reflector and a secondary reflector in the form of part of the upper sheet of a hyperboloid of revolution. The primary reflector is hexagonally segmented and rests in the bottom of the swing sphere. The secondary reflector is of the same size as the absent central hexagon of the primary reflector. The secondary reflector is positioned where it will be filled by the focused beam from the primary reflector, and the secondary focus is centered on the projected surface of the primary reflector.

The following definitions, parameter values, and equations were used.

Origin: Center of primary reflector rim circle

Positive z axis: Along the line of sight

Positive x axis: Through the center of a corner hexagon

$R = 6$ m = radius of telescope swing sphere

$D = 10$ m = aperture diameter

$n = 4$ = number of rings

$z_c = \sqrt{R^2 - (D^2/4)} = 3.317$ m; center of swing sphere is at $(0,0,z_c)$

ψ = polar angle for swing sphere

$x = R \sin(\psi)$ = x -coordinate of swing sphere

$z = R \cos(\psi) + z_c$ = z -coordinate of swing sphere

$w = D/(2n + 1) = 1.111$ m = width across flats of a hexagonal segment

$s = w/\sqrt{3} = 0.642$ m = side length of hexagonal segment

$f = 0.5$ = f number or focal ratio of primary reflector

Paraboloidal primary reflector surface equation

$$z = \frac{(x^2 + y^2)}{4fD} - \frac{D}{16f}$$

$D/(16f) = 1.250$ m = reflector concavity

$fD = F = 5.000$ m = distance from reflector center to primary focus

$z_{Fp} = fD - [D/(16f)] = 3.750$ m; primary focus is located at $(0,0,z_{Fp})$

$h = 0.833$ m = axial step height between tube edges at reflector ends

$$h = 2 \frac{fD - [D/(16f)]}{2n + 1}$$

$f_{fDw} = (fD/2) - fw + [w/(16f)] = 2.083$ m = distance involved in determining the secondary reflector

$f_s = (f^2 D^2/4) + (w^2/4) + f_{fDw}^2 = 10.899$ m² = area factor involved in determining the secondary reflector

$a^2 = (f_s - \sqrt{f_s^2 - f^2 D^2 f_{fDw}^2})/2 = 3.846$ m² = hyperboloidal secondary major parameter squared

$b^2 = c^2 - a^2 = (f^2 D^2/4) - a^2 = 2.404$ m² = hyperboloidal secondary minor parameter squared

$z_h = (fD/2) - [D/(16f)] = 1.250$ m = center of hyperboloidal secondary

$y_{omlp} = -[(3n/2) + 1]s = -4.490$ m = outer point of outer midlateral hexagon on primary

$z_{omlp} = -[D/(16f)] + [y_{omlp}^2/(4fD)] = 0.242$ m = outer point of outer midlateral hexagon on primary

$z = z_h + \sqrt{a^2 + (x^2 + y^2)(a^2/b^2)}$ = equation of hyperbolic secondary reflector

$z_{be0} = nh = 3.333$ m = height at bottom of central tube edge

A coordinate system was established in the plane of the primary reflector to make the positions of most features of the hexagonal grid equal to an integral number of units. In some cases, however, half-units had to be counted.

$u = w/2 = 0.555$ m = 1 unit in the x -direction

$t = s/2 = 0.321$ m = 1 unit in the y -direction

The cutting of the lower ends of the tubes to clear the focused beam from the primary reflector forms a kind of "ceiling" over the primary. This ceiling is in the form of six planes, convergent at the primary focus, forming a six-sided pyramid. The base of the pyramid was chosen to rest on the outer points of the outer-ring point hexagons. Each plane was

then determined by the primary focal point and two other base points, of which the following two are typical:

$$x_{c1} = 9 \text{ (in units of } u), y_{c1} = 1 \text{ (in units of } t), z_{c1} = 0 \text{ m}$$

$$x_{c2} = 5 \text{ (in units of } u), y_{c2} = 13 \text{ (in units of } t), z_{c2} = 0 \text{ m}$$

The minimum elongation angle E is the smallest angle that allows a ray to penetrate the sunshade to the primary reflector surface. This ray is one that crosses from a low point on the top of one hexagonal tube to a high opposite point on the

tube at the bottom, in a short tube, provided that afterwards the ray is incident on the primary reflector. The angle is calculated by giving the coordinates of the two opposite points of a tube, as follows, and trying various tubes until the largest angle E is found. In the following, subscript t refers to the top point, and b to the bottom point.

$$x_t = 9 \text{ (in units of } u), y_t = -1 \text{ (in units of } t)$$

$$z_t = z_c + \sqrt{R^2 - x_t^2 u^2 - y_t^2 t^2} = \text{coordinate (on sphere)}$$

$$x_b = 7 \text{ (in units of } u), y_b = 1 \text{ (in units of } t)$$

$$z_b = \text{coordinate (focused beam clearance)}$$

$$= z_{FP} - \frac{x_b [(z_{FP} - z_{c1})y_{c2} - (z_{FP} - z_{c2})y_{c1}] + y_b [x_{c1}(z_{FP} - z_{c2}) - x_{c2}(z_{FP} - z_{c1})]}{x_{c1}y_{c2} - x_{c2}y_{c1}}$$

E = minimum elongation angle

$$= \frac{180}{\pi} \tan^{-1} \frac{\sqrt{(x_t - x_b)^2 u^2 + (y_t - y_b)^2 t^2}}{z_t - z_b}$$

Each unique off-axis tube stands over an area completely within a sector defined by the positive x -axis and a radial line at 60 degrees from it. The axial tubes are split by the x -axis, with their positive halves standing over the sector just defined. The points of the tubes were lettered A, B, C, D, E , and F , in order counterclockwise starting with the point nearest the 60-degree sector line. The top and bottom coordinates for cutting the tubes were then found as the intersection of the vertical lines of the tubes (the projections of the hexagon points) with the "ceiling" or with the swing sphere.

i = number of the ring (center tube is 0)

j = number of hexagon in ring, from 1 on x -axis up to i

$$x_A = \begin{cases} 1 & \text{if } i = 0 \\ 2i - j & \text{otherwise} \end{cases}, y_A = \begin{cases} 1 & \text{if } i = 0 \\ 3j - 4 & \text{otherwise} \end{cases}$$

$$x_B = \begin{cases} 1 & \text{if } i = 0 \\ 2i - j + 1 & \text{otherwise} \end{cases}, y_B = \begin{cases} 1 & \text{if } i = 0 \\ 3j - 5 & \text{otherwise} \end{cases}$$

$$x_C = \begin{cases} 1 & \text{if } i = 0 \\ 2i - j + 2 & \text{otherwise} \end{cases}, y_C = \begin{cases} 1 & \text{if } i = 0 \\ 3j - 4 & \text{otherwise} \end{cases}$$

$$x_D = \begin{cases} 1 & \text{if } i = 0 \\ 2i - j + 2 & \text{otherwise} \end{cases}, y_D = \begin{cases} 1 & \text{if } i = 0 \\ 3j - 2 & \text{otherwise} \end{cases}$$

$$x_E = \begin{cases} 1 & \text{if } i = 0 \\ 2i - j + 1 & \text{otherwise} \end{cases}, y_E = \begin{cases} 1 & \text{if } i = 0 \\ 3j - 1 & \text{otherwise} \end{cases}$$

$$x_F = \begin{cases} 1 & \text{if } i = 0 \\ 2i - j & \text{otherwise} \end{cases}, y_F = \begin{cases} 1 & \text{if } i = 0 \\ 3j - 2 & \text{otherwise} \end{cases}$$

Let X stand for one of the letters A through F . Then

$$z_{top} = z_c + \sqrt{R^2 - x_X^2 u^2 - y_X^2 t^2}$$

$$z_{bottom} = z_{FP} - \frac{x_X [(z_{FP} - z_{c1})y_{c2} - (z_{FP} - z_{c2})y_{c1}] + |y_X| [x_{c1}(z_{FP} - z_{c2}) - x_{c2}(z_{FP} - z_{c1})]}{x_{c1}y_{c2} - x_{c2}y_{c1}}$$

A six-sided frustum of a pyramid, placed around the aperture in the primary reflector, prevents the entrance of any rescattered stray light from the primary reflector into the detector. It also limits the view from the secondary focal point to the secondary reflector. The larger base of the frustum is the same size as a hexagonal segment. The height above the primary reflector rim plane is determined by the intersection of a ray from the secondary focal point to a midlateral point of the secondary reflector and a ray from the primary focal point to a midlateral point of the central hexagon on the primary reflector. The calculations involve a pyramid factor $f_{pyr} = F/[z_{be0} + D/(16f) + F] = 0.522$. The height above the primary reflector mirror rim plane is $z_{Fp} - Ff_{pyr} = 1.145$ m. At the top of the pyramid, the distance to the edge from the center is $wf_{pyr}/2 = 0.290$ m, and the distance to the point from the center is $-sf_{pyr} = 0.335$ m.

A hexagonal cone (or a hexagonal cylinder) from the secondary focal point around the beam from the secondary reflector may be added to capture rays that are rescattered within the structure, or that enter through the inner ring tubes at less than the minimum elongation but would strike the pri-

mary reflector surface within the central hexagon. The height and spreading of the cone are determined by the intersection of the ray from the secondary focal point to a midlateral point of the secondary reflector and a ray passing through the innermost ring tube from the top outer midlateral point to the bottom inner midlateral point. This gives the distance from the center to the top edge of the cone as

$$w \frac{z_{te1} - 3z_{be0} - [2D/(16f)]}{2z_{te1} + 2z_{be0} + [D/(4f)]} = 0.127 \text{ m}$$

and the height (relative to the primary reflector rim plane) as

$$z_{te1} + \left[\frac{z_{te1} - 3z_{be0} - [2D/(16f)]}{2z_{te1} + 2z_{be0} + [D/(4f)]} - 3/2 \right] (z_{te1} - z_{be0})$$

$$= -0.199 \text{ m}$$