

Design and Test of a 2.25-MW Transformer Rectifier Assembly

R. Cormier and J. Daeges

Radio Frequency and Antenna Microwave Subsystems Section

A new 2.25-MW transformer rectifier assembly has been fabricated for DSS-13 at Goldstone, California. The transformer rectifier will provide constant output power of 2.25 MW at any voltage from 31 kV to 125 kV. This will give a new capability of 1 MW of rf power at X-band, provided appropriate microwave tubes are in the power amplifier. A description of the design and test results is presented in this article.

I. Introduction

High-power transmitters are operational on the 70-meter antennas of the Deep Space Network. These transmitters provide uplink communication to the planetary satellites, and provide radar capability at DSS-14 to research the solar planets and their moons.

High-power transmitter microwave tubes presently used and those projected for the future are listed in Table 1. Note in particular the change in body current requirements from the early tubes, such as the X-3060, and those presently designed, such as VKS-7864. A decrease of nearly two orders of magnitude is seen. The importance of this is in the design of the klystron's protective circuits. The body current is monitored in the ground return to the power supply, and an increase of body current indicates beam heating of the klystron cavities, with potential damage unless the beam is removed. Unfortunately, ground currents from the transformer rectifier assembly cannot be separated from body currents. These currents from the transformer rectifier cause false operation of the protective circuits, especially in the newer tubes, where the maxi-

mum body current is now less than the ground currents from other sources. This has led to a need for tighter control on the ground currents in the transformer rectifier assembly.

The prime power for the transformer rectifier is obtained from a motor-generator set. This arrangement has the advantage of generating a regulated ac that can be adjusted to any voltage from practically zero to 2400 volts. The generator field is controlled from the output dc high voltage, forming a closed feedback loop. A regulation of 0.01 percent is maintained long term. Full power is obtained only from 2200 to 2400 volts. A frequency of 400 Hz is used to reduce the size of magnetic components. In addition, this allows wider regulator bandwidth. Table 2 summarizes the capabilities of each of the stations.

The new transformer rectifier assembly has the capability of powering all tubes presently used or proposed for future use. The size is 103-1/2 inches wide by 98-3/4 inches deep by 115-5/8 inches high. The total weight is approximately 60,000 pounds. The assembly is shown in Fig. 1.

II. Transformer

The transformer windings are mounted on a three-legged core type magnetic circuit. The windings consist of 12 identical coils, four mounted side by side on each leg. The primaries on each leg are connected in parallel and the three legs are connected in delta. The primaries have eight taps to provide a 2 to 1 range of output voltage. The secondaries are individually connected in extended delta to provide four three-phase outputs. Two of the deltas are phase shifted -15 degrees while the other two are phase shifted $+15$ degrees. In effect, the transformer converts the three-phase input to two six-phase outputs. Each secondary feeds a full-wave bridge rectifier that converts the ac to dc voltage. A schematic of the transformer rectifier is shown in Fig. 2.

The use of extended delta windings has the advantage of physical coil symmetry. This makes the manufacturing process easier due to winding of identical coils. Electrically, the advantages are identical output voltage values for each set of deltas and equal inductances in each phase, which reduce the uncharacteristic harmonics on both the ac and dc sides of the transformer rectifier assembly [1].

The results of measurements of the dc harmonics are shown in Fig. 3. For comparison purposes, a plot of the old unit is included as Fig. 4.

The use of taps on the primary for a voltage range of 2 to 1 increases the power rating of the primary by a factor of two. The voltage obtained from an extended delta is reduced by 12 percent over a nontapped winding. This increases the power rating of the secondaries by 12 percent. The load also requires an increase in power rating of 5 percent for each of the secondaries and a 1 percent increase for the primaries. The transformer is required to deliver rated power with input voltages from 2200 Vac to 2400 Vac. This increases the power rating of both the primary and the secondaries by 9 percent. The total equivalent power rating of the transformer is 3.9 MVA. This is a very favorable rating for this application, considering that constant output power is delivered over a voltage range of 4 to 1. Of this, a 2 to 1 voltage range is obtained from the switching of the converter connections.

Another feature of the transformer is the use of secondary shields to distribute impulse voltages generated by the operation of a crowbar. The crowbar shorts the dc output during load arcs. The shields are an alternative method to that of space-winding the top layer of each secondary coil.

III. Converter

The transformer generates two sets of six-phase outputs. Each six-phase output connects to two series full-wave bridge

rectifiers to form a 12-pulse converter. The two 12-pulse converters are connected either in series or in parallel on the dc side. This provides a 2 to 1 range of output voltages. One range is from 31 kV to 62 kV, the other is 62 kV to 125 kV. Full utilization of the voltage and current rating of the rectifiers is made in this configuration because the parallel-to-series switching is made at the output of the converter. Performing the switching at the output of the rectifiers has the added advantage of not requiring an interphase balancing transformer. The three-phase transformer provides the necessary inductance to balance the currents between the two converters when operating in parallel.

The conversion of ac to dc generates harmonics both on the dc side of the converter and on the ac lines. For a perfect system, only characteristic harmonics are generated. These are of order np on the dc side and $np \pm 1$ on the ac side, where n is the harmonic number and p is the converter pulse number. The assumption of a perfect system is never valid with real equipment. If a perfect system is represented by the positive sequence of electrical components, then imperfections can be represented by the negative sequence. Some imperfections are generated in the ac source and others are generated in the transformer. The generator also contains a negative sequence component.

The transformer requires windings with a turn ratio of $\sqrt{3}$. Since $\sqrt{3}$ is an irrational number, it can only be approximated by a fraction. This generates an asymmetry in the output voltage. The resulting negative phase sequence generates uncharacteristic harmonics. Another source of uncharacteristic harmonics is unequal inductances in each phase, but this is not a problem in this equipment due to the symmetry of the transformer coils.

The testing for dc harmonics was made with a voltage divider and a waveform analyzer. The transformer rectifier operated into a resistive load with no filter. The data compares the old unit at DSS-13 with the new unit. The old unit consisted of a delta primary and a tapped wye secondary with rectifiers connected for six-pulse operation.

The advantage of 12-pulse over six-pulse converters is a reduction by 12 dB in the principal component of the dc harmonic. The lowest frequency component for a six-pulse converter is $6f$, while for a 12-pulse it is $12f$, where f is the line frequency. For the old unit, the $6f$ component measured -21.3 dB referenced to the dc output voltage. For the new unit, the $12f$ component measured -35.8 dB. The theoretical value is -36 dB.

The advantages of a 12-pulse converter quite often are not realized due to uncharacteristic harmonics. Because the lowest

frequency components are the most difficult to filter, it is the value of these that must be reduced. The value of harmonics below the 12th are comparable for both units, except of course the sixth harmonic, which becomes an uncharacteristic harmonic for the 12-pulse converter. A value of -46.7 dB was measured for this harmonic in the new unit. This represents a reduction by a factor of 19 over the old unit.

The use of converters with increased pulse numbers is advantageous only if the uncharacteristic harmonics are kept low. The reduction obtained by the use of extended delta windings is significant and proves the advantages of tightly controlling the symmetry of the transformer coils. Both design and manufacturing are needed to achieve these results.

IV. Shielding

The stray capacitances were measured on the old transformer rectifier assembly at DSS-13. A measured value of 3.3 *nf* was obtained between the secondaries of the transformer and the tank. The measurement was repeated on the new unit and a value of 4.4 *nf* was obtained. The increased size of the new unit accounts for the larger value.

An electrostatic shield was placed inside the tank that encloses both the transformer and the rectifiers. This shield was then brought out to a separate terminal that will be connected to the return side of the load. The purpose is to prevent displacement currents from being conducted in the load. The shields in the new unit decreased the stray capacitance to the tank by 77 percent. (The actual value measured is 1.0 *nf*, compared to the unshielded unit of 4.4 *nf*.) This improvement is not as good as desired. The stray capacitances should be less than 100 *pf* if the ground currents from this source are going to be reduced to a value comparable to the body current of the newer klystrons; this requires an improvement in shielding of 97.7 percent from a unit without shielding. Although this level of improvement was not achieved, the 77 percent improvement represents an important step in decreasing and controlling ground currents.

The changes in tank current under operation are shown in Fig. 5(a) for the old unit and in Fig. 6(a) for the new unit. Note that the frequency is much higher for the new unit with no low-frequency components. Tests so far indicate no false triggering of the crowbar, although it is too early to conclude that the problem has been solved. Certainly, a lower value of ground current is desirable, but the design of a transformer would be made difficult if additional shielding were required. The use of box shields around the secondaries, although theoretically possible, would increase the size and weight of the transformer and consequently the cost. Such shielding inter-

feres with the cooling of the coils, and also increases the margins, which in turn increases the size of the coils and the amount of iron for the core.

Measurement of ground currents at the generator was made in the ground return. The results are shown in Fig. 5(b) for the old unit and in Fig. 6(b) for the new unit. The transformer rectifier is a balanced three-phase load without a neutral connection. No zero sequence component is possible except as a result of capacitances between the transformer windings and the tank. Although an increase in current has been measured, this current should not affect the operation of the crowbar. No interference will be experienced as long as these currents do not pass in the load circuit.

V. Power Capability

The transformer rectifier is rated to deliver 2.25 MW to its load. Using this as the basis, a per-unit circuit of the 400-Hz supply is shown in Fig. 7. The transformer consists of four tap primaries connected in delta. The secondaries consist of four extended deltas. A total of 12 coils are mounted on the three legs of the core. Each converter is rated for one-quarter of the load, namely 562,500 watts. The cable between the generator and the transformer rectifier unit is estimated to have a 6 percent reactance. The generator is rated for 1.3 MVA into a 0.9 power factor load, and has a 1.0 per-unit reactance. The calculations assumed a second generator identical to the existing one now installed at the site. (This would provide a capacity of 2.6 MVA.) The procurement of a second generator with identical characteristics may be a problem because General Electric, the original manufacturer, has indicated that they will not manufacture another unit.

The converter power factor is 0.955 at the secondary of the transformer. The combining of converters improves the power factor on the line side of the transformer to 0.989. This was taken into account in calculating the per-unit parameters. The values of power factor and load vary with tap position. These values are summarized in Figs. 8 and 9.

A simulated load test was performed at the manufacturer's plant. The output of the rectifiers was short-circuited and the applied voltage was raised until rated load current was measured at the output. The test was performed on the worst tap for heating of the transformer winding. This type of test has a number of shortcomings. Among these are the disregard of core losses, winding resistance change due to frequency (the test was performed at 60 Hz), reverse-leakage current losses in the rectifiers, and rectifier switching losses. Even so, the test does account for the major losses in the unit. The input was measured as 25 kW.

For the first seven hours, the water coolant flow was set to zero. The temperature rose at a constant rate of 3 °C per hour with no sign of stabilization. The water coolant was turned on and the temperature stabilized at 24 °C above air-ambient and 11 °C above the water-inlet temperature. The amount of heat carried by the water was 14 kW; the remaining 11 kW was transferred through the tank walls to the air. The unit is rated to operate at 35 °C above air-ambient and 27 °C above water-inlet temperature. If it is assumed that the heat-transfer coefficient is constant over the temperature range of interest, then the unit is capable of dissipating 50 kW of internal heat. Since the worst-case calculated heat is 40 kW and the thermal time constant for this unit is much longer than the maximum temperature is ever expected to last in any one day, the transformer rectifier appears to be conservatively rated to handle 2.25 MW.

A load test was also performed at DSS-13. This test was at the 1-MW level because a higher power load was not available. The results are consistent with the short-circuit load test previously made at the vendor's plant.

The losses are summarized in Table 3. The copper losses are in close agreement with calculations. The core losses are much lower than calculated, and the measurement is suspect. The rectifier losses were not measured and the data is based on calculations.

VI. Impedance Test

From the data, the resistances were calculated so that comparisons could be made between the ac and dc values (see Table 4). The values are for all primaries connected in parallel and for one extended delta secondary short circuited. The values are referred to the primary. Table 4 lists only the values of one of the secondaries; the data for the other secondaries were equal to those listed within the accuracy of the measurements. Note some interesting results. The ac resistance is greater than the dc resistance, which is expected, but the ac resistance increased more rapidly than the dc resistance on the taps that included copper foil in the primary. (The primary winding consists of wire for the first 30 turns and foil for the remainder; the foil has higher ac resistance due to current con-

centration at the edges.) Note also that the leakage inductance decreases at the higher output voltages.

VII. Insulation

Testing of the winding layer insulation consisted of an induced voltage of 1.5 times the operating voltage for a duration of one minute. This was done with the rectifiers disconnected. A dielectric potential test of 150 kV rms was also applied to the rectifiers for a duration of one minute. Shields and the primary windings to ground were tested at 10 kV rms. These tests were performed to verify the integrity of the insulation. No arcing of the transformer rectifier unit was observed in any of the tests. (During the 150-kV test of the rectifiers, arcing was experienced with the cable connecting the test equipment to the unit.)

VIII. Output Voltages

The output voltage at light loads (E_{do}) is the basis for most calculations of converter performance. The values of E_{do} were calculated based on the turn ratio of the transformer. Measurements were made to check the validity of the calculated values; these are given in Table 5 in the "Data, kV" column.

The open-circuit output voltages were measured for the series connection only and are listed in the "No Load, kV" column in Table 5. The values for the series connection indicate an average of 15.5 percent over voltage above E_{do} , which is also the theoretical value of open circuit over voltage.

IX. Conclusion

The new transformer rectifier uses a number of techniques that provide advantages over previous designs. The use of 12-pulse converters generated from extended deltas has reduced the values of dc harmonic ripple. The use of series/parallel switching doubles the range of voltage output without any increase in the rating of the transformer or the rectifiers. The use of shielding has decreased ground currents, but further improvements in this area are still desired. Further design refinements are possible by extending these techniques.

Reference

- [1] J. Arrillaga, D. Bradley, and P. Bodger, *Power System Harmonics*, New York: John Wiley & Sons, 1985.

Table 1. High-power transmitter output tubes

Klystron model no.	Power, kW	Beam V, kV	Beam I, A	Body I, mA	Band
X-3060	100.0	36.0	7.7	540	S-Band
VKS-8274	125.0	36.0	7	12	S-Band
X-3070	450.0	63.0	16.0	1200	S-Band
X-3075A	500.0	63.0	16.0	1200	S-Band
VKS-8276	500.0	60.0	17	15	S-Band
VA949	200.0	51.0	11	20	X-Band
VKX-7864	250.0	50.0	11	15	X-Band ^a
2 ea VKX-7864	500.0	50.0	22	30	X-Band ^a
4 ea VKX-7864	1000.0	50.0	44	60	X-Band ^a
Gyroklystron	400.0	100.0	10	25	Ka-Band ^a
Gyroklystron	1000.0	100.0	20	50	X-Band ^a

^aProjected.**Table 2. Station transmitter supply capability**

Station	Voltage, kV	Current, A max	Power output, MW	Generator rating, MVA
DSS-13	30-33 and 45-70	30.3	1	1.3
DSS-14	54-90	16.7	1	1.3 ^a
DSS-43, DSS-63	42-76	21.7	1	1.3
New T/R	31-125	72.6	2.25	

^aWith capability of expansion to 2.6 with an additional generator.**Table 3. Losses**

Tap number	Copper losses, W	Core losses ^a , W	Diode loss, W
1	19100	1400	20440
2	16376	1800	18650
3	13660	2240	17150
4	12056	2640	15650
5	10372	3080	14400
6	8740	3840	13200
7	7080	4720	12070
8	5912	5880	11000

^aThese are very low values; the measurement may have been in error.

Table 4. Winding resistance and leakage inductance per section

Tap number	dc resistance, mohm	ac resistance, mohm	Inductance, μ henry
1	92.68	194.6	397.1
2	81.74	168.5	343.8
3	72.62	139.3	293.3
4	65.28	123.9	256.8
5	58.89	106.0	223.1
6	52.99	89.45	191.3
7	47.44	72.33	162.6
8	40.90	61.16	133.2

Table 5. Output dc voltages

Tap number	Series connection			Parallel connection	
	No load, kV	E_{do} , kV	Data, kV	E_{do} , kV	Data, kV
1	88.3	74.7	73.7	35.8	36.8
2	91.5	80	79.7	38.6	39.8
3	99.5	88.4	86.8	42	43.4
4	106	96	93	45.3	46.5
5	113	104	100	48.8	50.1
6	124	111	108.5	52.8	54.2
7	135	120	118	58	59.2
8	151	134	130	63.3	65.1

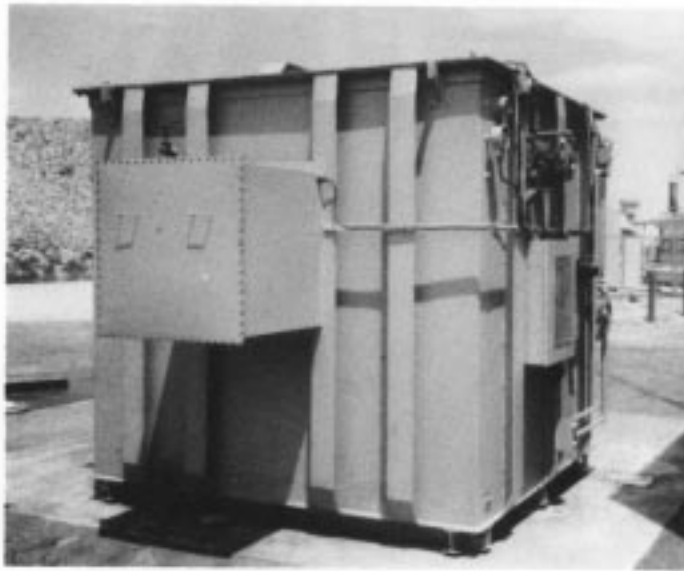

Fig. 1. Transformer rectifier assembly.

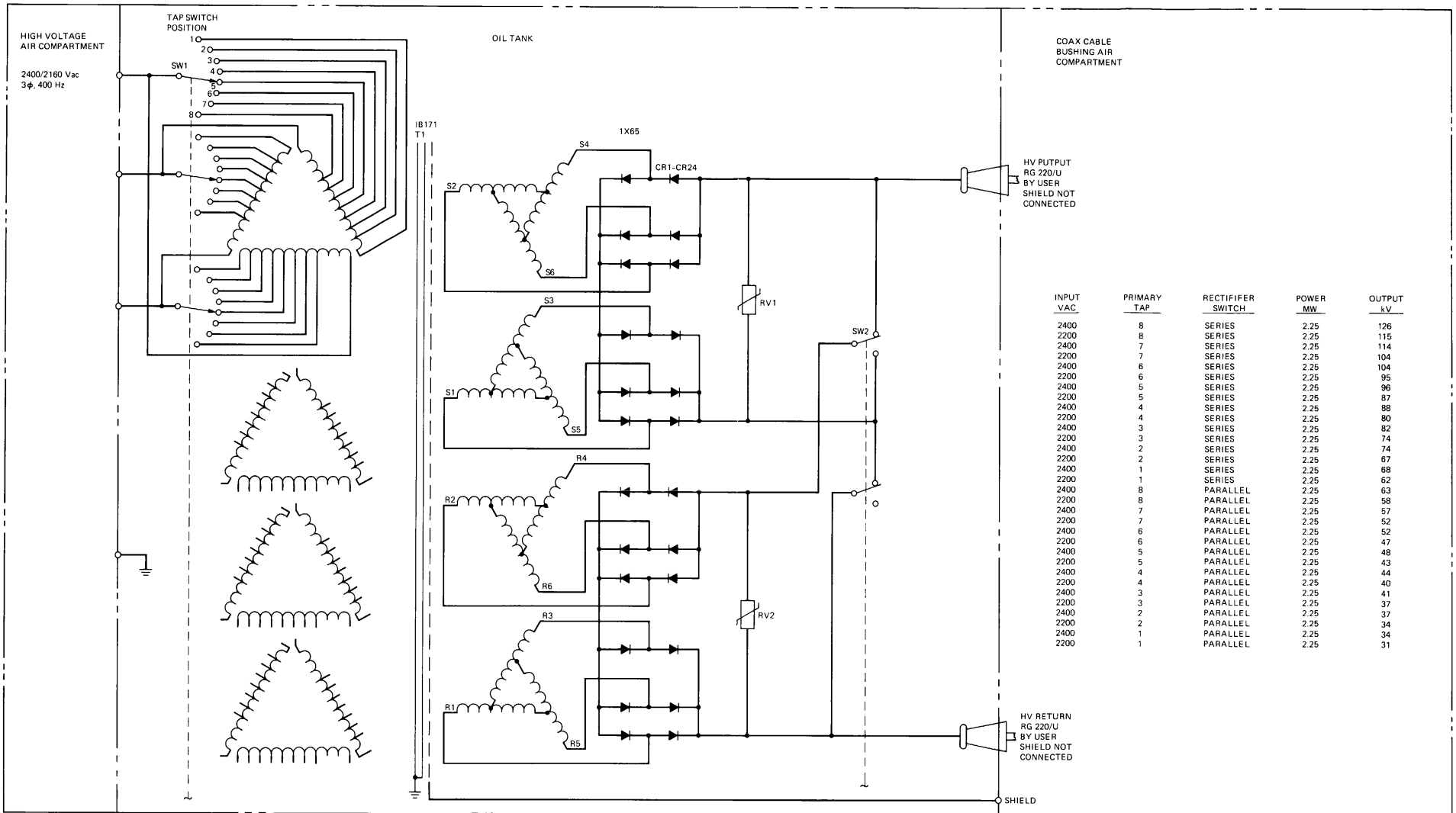

Fig. 2. Transformer rectifier assembly detailed schematic.

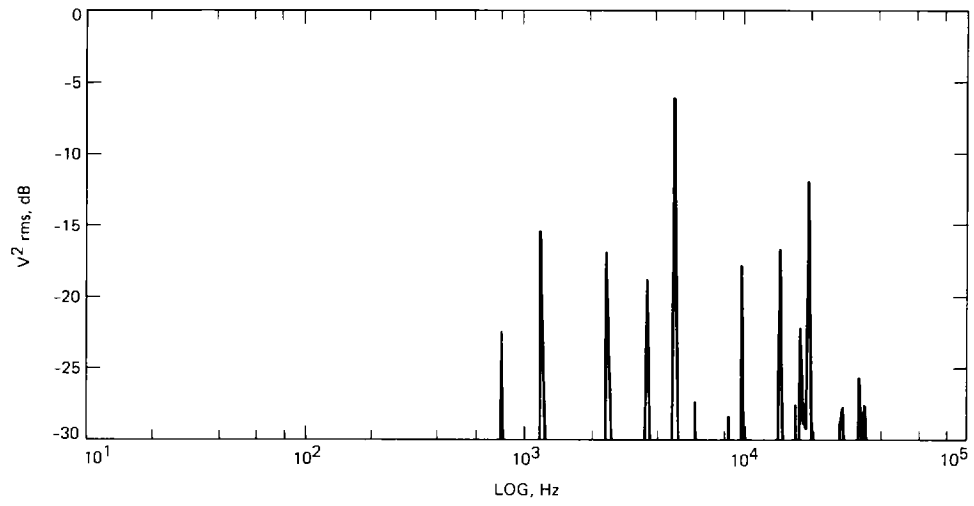

Fig. 3. New harmonic rectifier assembly dc harmonics.

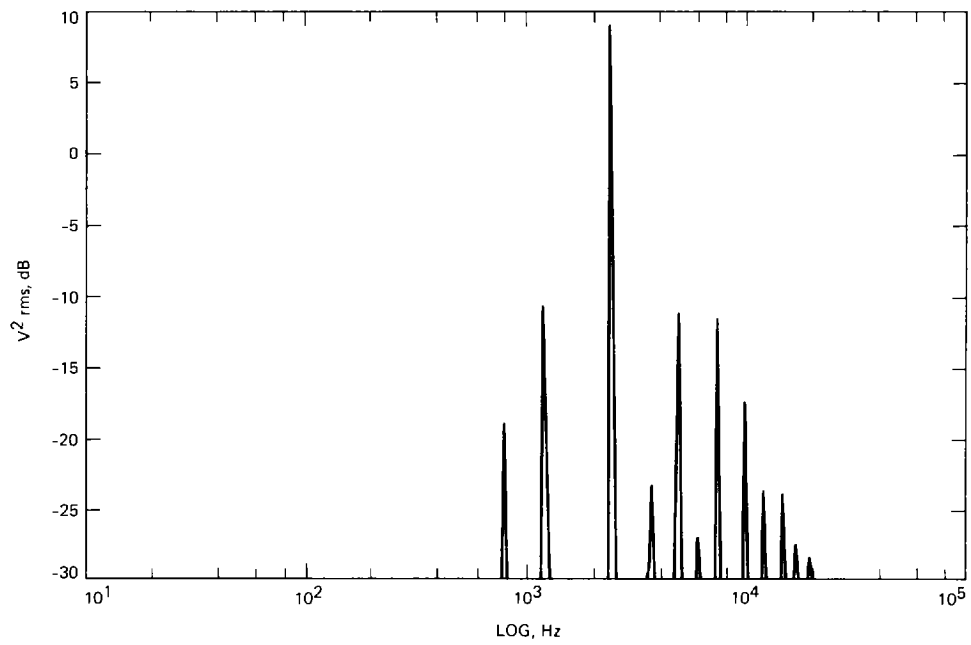

Fig. 4. Old harmonic rectifier assembly dc harmonics.

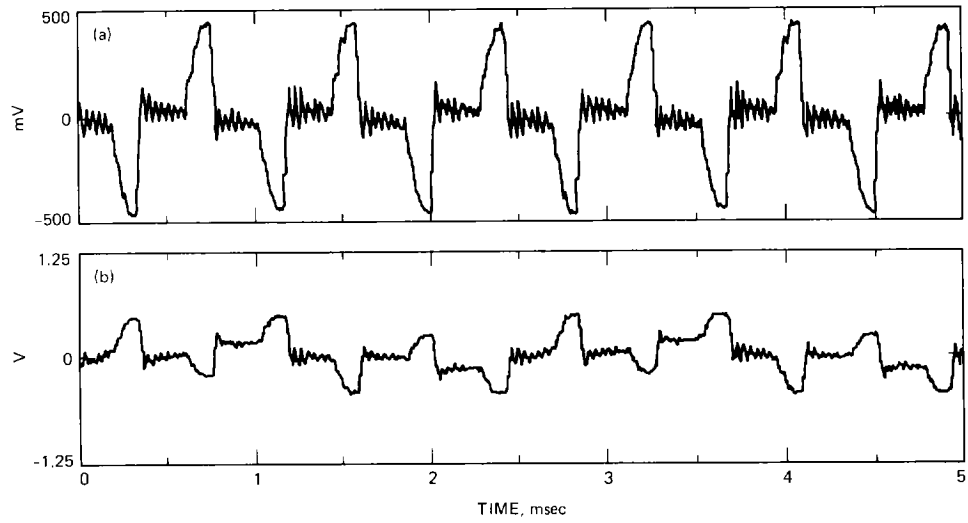

Fig. 5. Old harmonic rectifier assembly harmonics, (a) body, (b) generator.

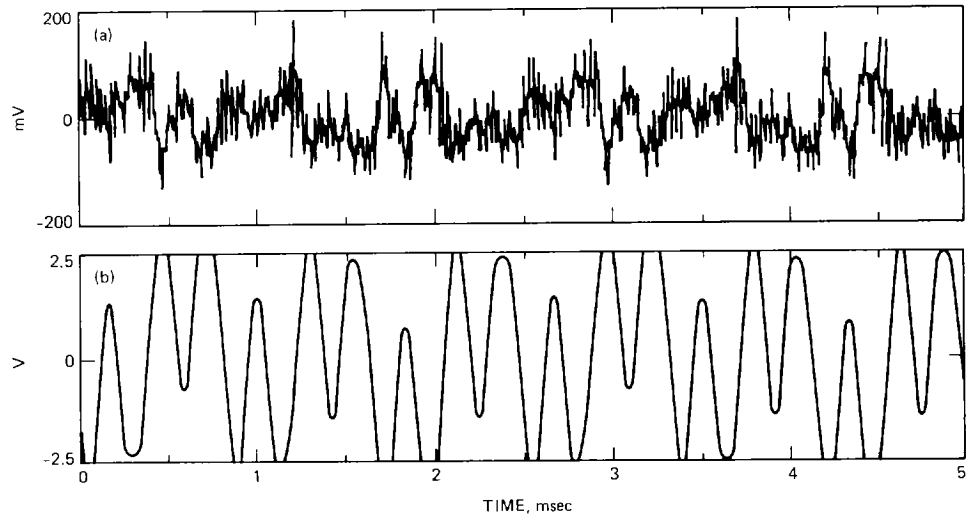

Fig. 6. New harmonic rectifier assembly harmonics, (a) body, (b) generator.

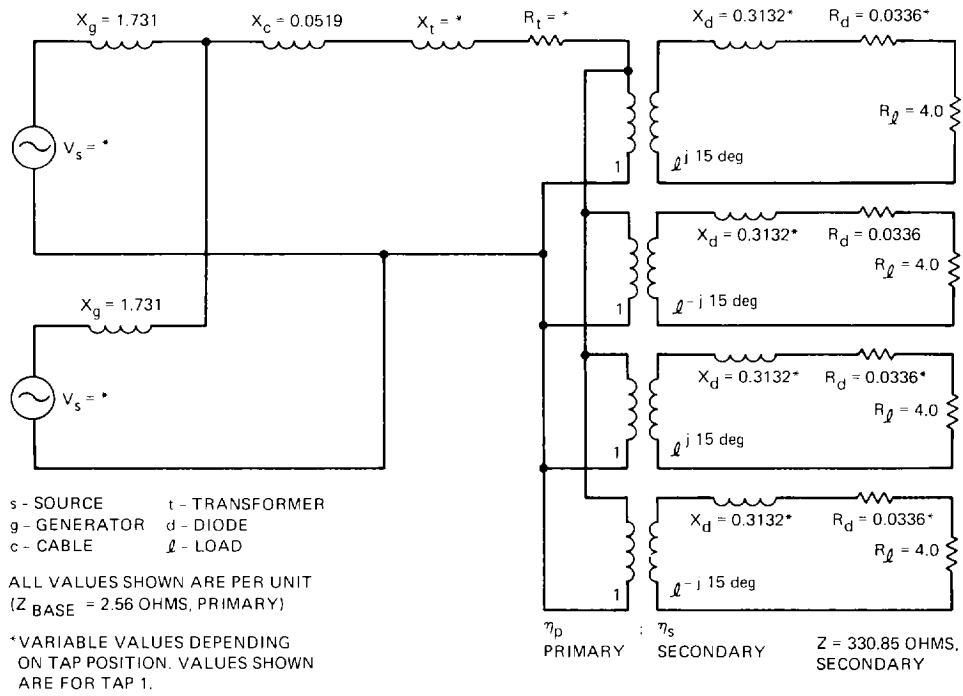

Fig. 7. 400-Hz power distribution per unit circuit.

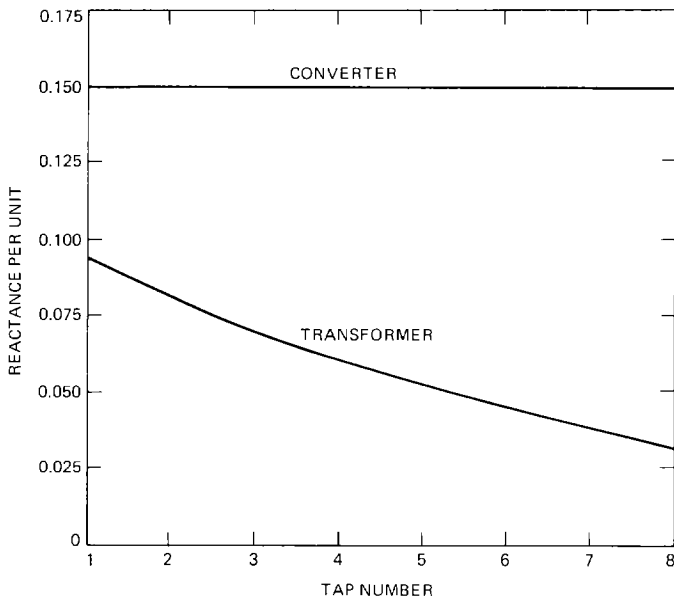

Fig. 8. Load reactance.

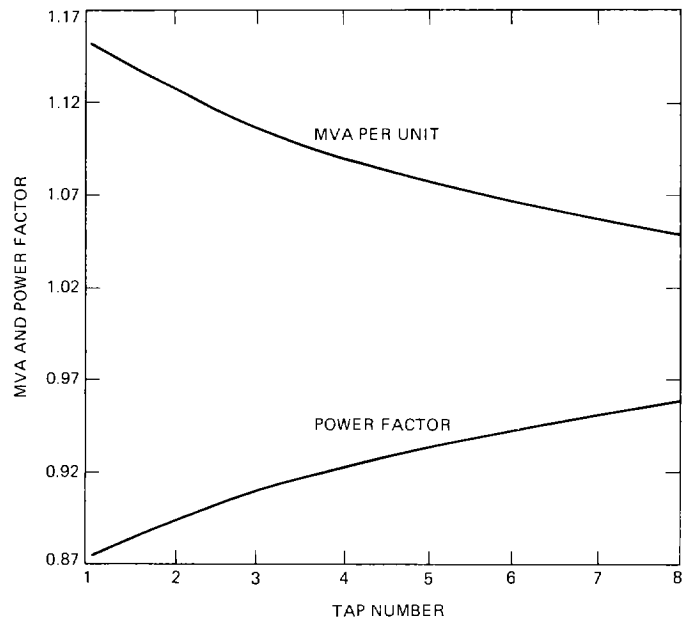

Fig. 9. Generator load.