

State-of-the-Art Fiber Optics for Short Distance Frequency Reference Distribution

G. Lutes and L. Primas

Communications Systems Research Section

A number of recently developed fiber-optic components that hold the promise of unprecedented stability for passively stabilized frequency distribution links are characterized. These components include a fiber-optic transmitter, an optical isolator, and a new type of fiber-optic cable. A novel laser transmitter exhibits extremely low sensitivity to intensity and polarization changes of reflected light due to cable flexure. This virtually eliminates one of the shortcomings in previous laser transmitters. A high-isolation, low-loss optical isolator has been developed which also virtually eliminates laser sensitivity to changes in intensity and polarization of reflected light. A newly developed fiber has been tested. This fiber has a thermal coefficient of delay of less than 0.5 parts per million per °C, nearly 20 times lower than the best coaxial hardline cable and 10 times lower than any previous fiber-optic cable. These components are highly suitable for distribution systems with short extent, such as within a Deep Space Communications Complex. In this article these new components are described and the test results presented.

I. Introduction

The transmitter exciter, local oscillator, and receiver delay calibration system in a Deep Space Station (DSS) require stable frequency references. Hydrogen maser frequency standards generate these frequency references, which then must be distributed to the systems that use them. The distribution system must not add appreciable phase noise or frequency instability to the signal being distributed.

All distribution systems degrade the phase and frequency stability of transmitted frequency reference signals [1]. A reduction in the signal-to-noise ratio (SNR) of a transmitted signal and delay changes in the transmission path are the pri-

mary causes of degradation. These effects are caused by distribution system noise, which reduces the SNR, and variations in the environmental temperature, which cause delay changes. The degree of delay change is dependent on the Thermal Coefficient of Delay (TCD) of the distribution system components.

Fiber-optic systems have several major advantages over conventional distribution systems, which usually employ coaxial cables. Since fiber-optic systems use all dielectric cable, they are not subject to ground loops and are generally immune to pick-up of electromagnetic interference (EMI) and radio frequency interference (RFI). The very low loss at high frequencies in a fiber-optic system helps preserve the SNR of a transmitted signal. Also, new fiber-optic cables with very low TCD,

recently developed and available commercially, can greatly reduce temperature induced delay changes.

A major disadvantage of fiber-optic systems in frequency distribution applications has been the laser's sensitivity to reflections from the cable. Light reflected back into the laser from the cable affects the phase of the optical carrier's modulation as measured across the laser. Cable flexure and vibration cause changes in the polarization and amplitude of this reflected light. These changes in the reflected light result in phase changes across the laser and therefore across the fiber-optic link [2]. Recent developments, which will be described in this article, have virtually eliminated this problem.

Because of the potential improvements in performance, the Time and Frequency Systems Research Group is developing stable, short distance fiber-optic links to distribute local frequency references within the Deep Space Stations (DSSs) of the Deep Space Network (DSN). These links will distribute the frequency reference signals from the frequency and timing interface in each station to the users within the station.

The requirements for the short links are quite different from the requirements for the long links used for frequency reference distribution between stations at the Goldstone Deep Space Communications Complex (DSCC). Because of cost-performance tradeoffs between short fiber-optic links and coaxial cable links, the short fiber-optic links must be relatively inexpensive, simple, and reliable.

The long distance fiber-optic links are more expensive and more complex, requiring optical and electronic feedback to stabilize the delay of a transmitted signal. The long links enable the use of a centralized frequency and timing facility, thus reducing the number of expensive frequency standards needed in a DSCC. Therefore, a higher cost for these links can be justified.

The performance of a short fiber-optic link is expected to be considerably better than the performance of an equivalent coaxial cable link. The fiber-optic link will eliminate ground loops and provide considerable improvement in the thermal stability of the cable. The optical fiber's superior thermal stability will reduce the need to add mass and insulation to the cable to increase its time constant. It will also reduce the temperature stability requirement for the air conditioning systems in certain areas of the stations.

The cables used in short fiber-optic links within a station may be exposed to temperature variations that can exceed 6°C in 20 minutes and 30°C in 12 hours over some portion of their length. They cannot be buried like long links at Goldstone to benefit from temperature isolation provided by

burial. These links may also be subjected to vibration from equipment such as air conditioners. For some applications the cables will be routed through the antenna wrap-up where they will be flexed when the antenna is moved. This relatively dynamic environment requires that the links be insensitive to cable vibration and flexure and that cables with low TCD be utilized.

In the remainder of this article, new technology that can be used to meet the special requirements of the short distance fiber-optic frequency reference distribution links will be discussed. Test results from an experiment that demonstrates an optically isolated laser's insensitivity to cable flexure and vibration will also be presented. Finally, a state-of-the-art fiber-optic frequency distribution link for short distance applications will be described.

II. Reducing Instabilities Caused by Reflections

Cable flexure can cause group delay changes as large as 200 psec across a fiber-optic link if no means is used to desensitize the laser diode to reflections. Optical isolation of the semiconductor laser diode can reduce such changes to less than 0.03 psec. The optical isolation can be obtained by the use of bulk optical isolators using the Faraday principle.

Optical isolators of this type consist of a polarizer to fix the polarization of the laser light, followed by a Faraday rotator which rotates the polarization vector by 45 degrees. The light at the output of the rotator enters an output polarizer with its axis rotated 45 degrees with respect to the polarization axis of the first polarizer. Therefore, the light passes through the output polarizer unimpeded. Because the Faraday principle is nonreciprocal in the forward and reverse directions, light reflected back into the isolator assembly experiences a rotation angle which is crossed with the axis of the input polarizer. The reflected light is therefore blocked, providing the reverse isolation.

The degree of isolation achieved by this type of isolator strongly depends on the amount of light scattered within the isolator. Once polarized reflected light scatters within the isolator, the polarization is lost, and components that do not have their axis crossed with the exit polarizer pass through and degrade the isolation.

Optical isolators of this type are manufactured by several companies. The isolation afforded is typically 35 to 40 dB and the forward loss is typically less than 2 dB. Although this level of isolation is very good, it is not adequate for precise fiber-optic frequency distribution. In order to improve laser isolation, one company in Japan has developed a laser diode with

an integral dual (two isolators in series) optical isolator.¹ This approach provides high isolation at the expense of an additional isolator and additional forward loss.

An optical isolator system developed at JPL to be used in frequency distribution links provides up to 70 dB isolation and 1.3 dB forward loss [3]. The JPL isolator system was assembled from a commercial bulk isolator, as described above, and expanded beam single-mode fiber connectors (Fig. 1). The first expanded beam connector expands and collimates the optical beam emitted by the fiber. The highly collimated beam passes through the isolator elements and is collected by the second connector. The total loss is only 1.3 dB in the forward direction.

The improvement in isolation of the JPL system is due to the narrow acceptance angle of the expanded beam connectors. The collimated reflected light with the appropriate polarization is rejected by the exit polarizer. The narrow acceptance angle of the input connector rejects the scattered reflected light exiting the isolator because it is not parallel to the axis of the isolator.

III. Low Thermal Coefficient of Delay Optical Fiber

Sumitomo Electric Industries, Ltd. of Japan has developed a low Thermal Coefficient of Delay (TCD) single-mode optical fiber [4]. This is an elegant means for reducing frequency instabilities in a reference frequency distribution system. It affords considerable improvement in transmission stability without adding to the complexity or reducing the reliability of the transmission system.

The TCD of this fiber has been measured at JPL and found to be less than 0.5 parts per million per °C (ppm/°C) from 0°C to 30°C. At around 0°C the TCD is zero. It rises slowly as the temperature rises and is 0.5 ppm at about 30°C. The curve in Fig. 2 shows the TCD for this fiber in ppm/°C versus temperature. Figure 3 compares the TCD of this fiber with the TCD of standard single-mode fiber and 7/8-inch diameter coaxial hardline (64-875 RG254/U). This coaxial hardline has the lowest average TCD for any coaxial cable measured by the Time and Frequency Systems Research Group at JPL. It can be seen that the TCD of the fiber at 25°C is 20 times lower than that of the coaxial cable. Use of the low TCD optical fiber would result in an Allan deviation 20 times lower than a system using the RSG254/U coaxial cable.

The TCD of a standard optical fiber results from two effects: the temperature dependence of the index of refraction of the fiber material, and the thermal coefficient of expansion of the fiber. An increase in temperature causes the index of refraction to decrease, which in turn decreases the group delay through the fiber. An increase in temperature also causes expansion of the fiber, which results in an increase in the group delay through the fiber. These two effects partially cancel resulting in a TCD for standard single-mode fiber of about +7 ppm/°C [5].

Sumitomo achieves a low TCD fiber by coating a standard fiber with an inner layer of elastic material and an outer layer of liquid crystal material having a negative thermal coefficient of expansion. This liquid crystal material compresses the fiber longitudinally with rising temperature. The compression of the fiber increases the index of refraction of the fiber material, which increases the group delay through the fiber. Compression of the fiber also decreases the change in length of the fiber, which decreases the group delay through the fiber. The result of these two effects is to impart a negative TCD to the fiber.

The thermal coefficient of expansion of the liquid crystal material is too high and would result in a net negative TCD for the fiber if it were applied directly to it. The layer of elastic material between the fiber and the liquid crystal coating couples the right amount of force from the liquid crystal material to the fiber to result in a near zero TCD for the fiber.

IV. Test Results

A single-mode fiber system using an isolated laser was tested in situ to demonstrate the capability to transmit precise reference frequencies through an antenna wrap-up. For this test a single-mode six-fiber cable was installed, as shown in Fig. 4, from the control room through the wrap-up of an antenna at the Goldstone DSCC. The cable, which is 850 meters long, is flexed when the antenna is moved.

A 100-MHz reference signal was transmitted through one fiber in the cable to the antenna and returned through another fiber back to the control room. At the control room the phase of the return signal was compared to the phase of the transmitted signal. Without the optical isolator between the cable and the laser transmitter, phase jumps were observed in the return signal when the antenna was moved. Figure 5(a) shows these phase jumps. However, when the optical isolator was used no phase jumps were observed as shown in Fig. 5(b).

The resultant Allan deviation for these measurements is shown in Fig. 6. The phase jumps observed when the optical isolator is not used cause the Allan deviation to be higher. The

¹Matsushita Electric Corporation of America, Secaucus, New Jersey, Model IMS09111-33.

optical isolator eliminates the phase jumps and therefore reduces the Allan deviation.

V. A Stable Distribution Link

Figure 7 is a block diagram of a stable fiber-optic distribution link which uses the developments described in this article. The reference signal to be transmitted is applied to the modulation input of the laser transmitter. The laser transmitter is either desensitized to reflections by dithering the bias or is followed by an optical isolator. A low TCD optical fiber carries the transmitted signal from the laser transmitter to the optical detector. The optical detector is followed by a high gain wideband amplifier with low TCD. A phase locked filter at the output of the link reduces the noise bandwidth of the receiver, which reduces the short term noise of the signal. The bandwidth of this PLL is adjusted for best overall frequency

stability, which depends on the quality of the oscillator in the PLL and the quality of the signal being transmitted.

VI. Conclusion

Stable short distance fiber-optic links for frequency reference distribution have been demonstrated. They have been found to be as good as coaxial systems for short term noise and much better than coaxial systems for long term stability. This improved long term stability results in a lower Allan deviation than can be achieved with coaxial cable under identical environmental conditions. In some critical applications, active electronic feedback is used to reduce thermally generated delay change. The use of low TCD optical fiber may in some cases eliminate the need for active electronic reduction of delay variations. This could result in less complex distribution systems for some applications.

Acknowledgments

The authors thank P. Tu, N. Mroczka, and W. Diener for making measurements presented in this paper. The authors also thank S. Kato, S. Tanaka, T. Kakuta, and M. Shindo of Sumitomo Electric USA, Inc. and Sumitomo Electric Industries, Ltd. for providing low TCD fiber for testing as well as information and data. Finally, the authors thank L. Maleki, J. Dick, R. Sydnor, and R. Logan for their help and support throughout the course of this work.

References

- [1] G. Lutes, "Reference Frequency Distribution Over Optical Fibers: A Progress Report," *Proceedings of the 41st Annual Symposium on Frequency Control*, IEEE Catalog No. 87CH2427-3, Philadelphia, Pennsylvania, pp. 161–166, May 1987.
- [2] K. Y. Lau, "Microwave Phase Stability of Directly Modulated Semiconductor Injection Lasers," *Applied Physics Letters*, vol. 52, no. 17, pp. 1377–1378, April 1988.
- [3] G. Lutes, "Optical Isolator System for Fiber-optic Uses," *Applied Optics*, vol. 27, no. 7, pp. 1326–1328, April 1988.
- [4] T. Kakuta and S. Tanaka, *LCP Coated Optical Fiber with Zero Thermal Coefficient of Transmission Delay Time*, Sumitomo Electric Industries, Ltd., 1, Taya-cho, Sakae-ku, Yokohama, 244, Japan.
- [5] A. Bergman, S. T. Eng, A. R. Johnston, and G. F. Lutes, "Temperature Dependence of Phase for a Single-mode Fiber Cable," *Proc. Third International Conference on Integrated Optics and Optical Fiber Communications*, OSA-IEEE, San Francisco, California, p. 60, April 27–29, 1981.

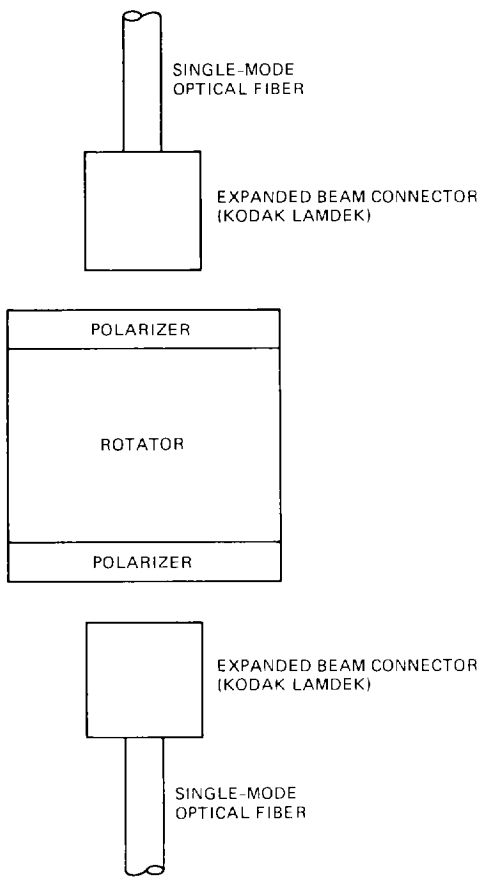

Fig. 1. A block diagram of the optical isolator assembly used to isolate the semiconductor laser from external reflections.

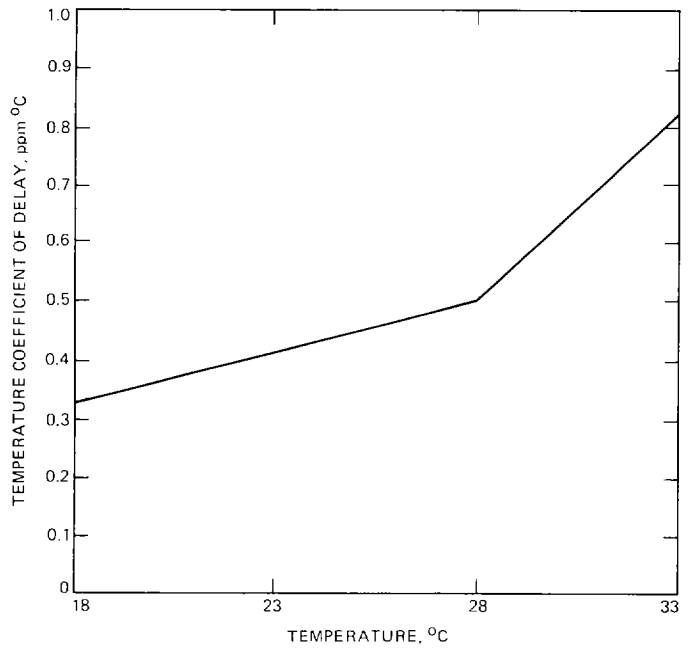

Fig. 2. The rate of change of group delay with respect to temperature for the Sumitomo low-TCD fiber.

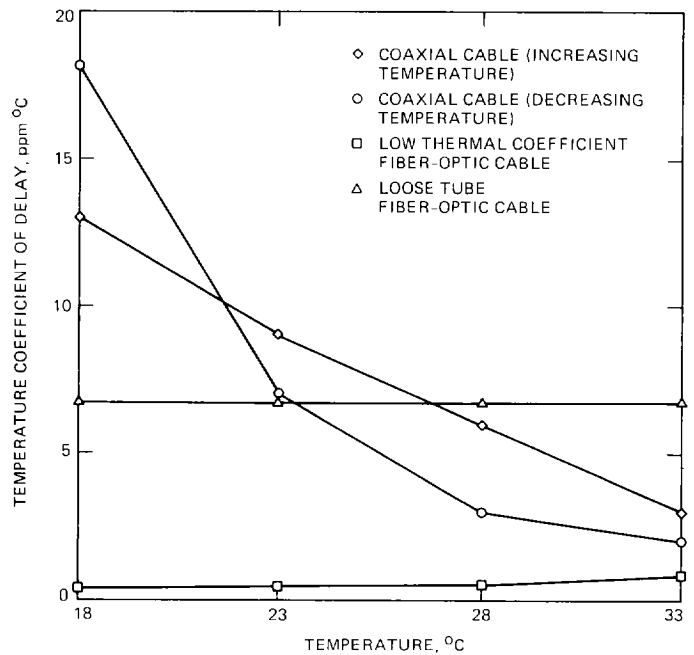

Fig. 3. A comparison of TCDs for the Sumitomo fiber, standard single-mode fiber, and 64-875 RG254/U, 7/8-inch diameter coaxial cable.

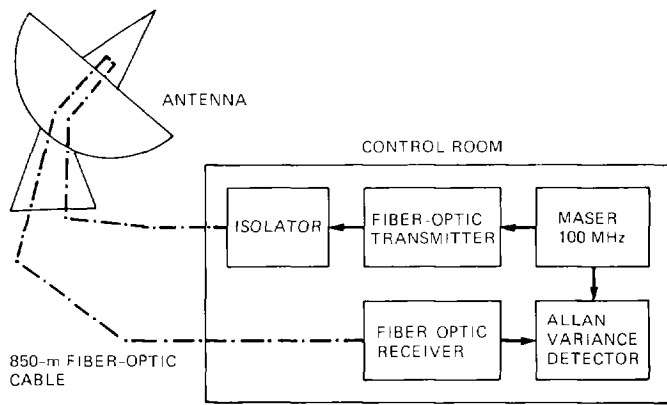

Fig. 4. A block diagram of the in-situ phase stability test.

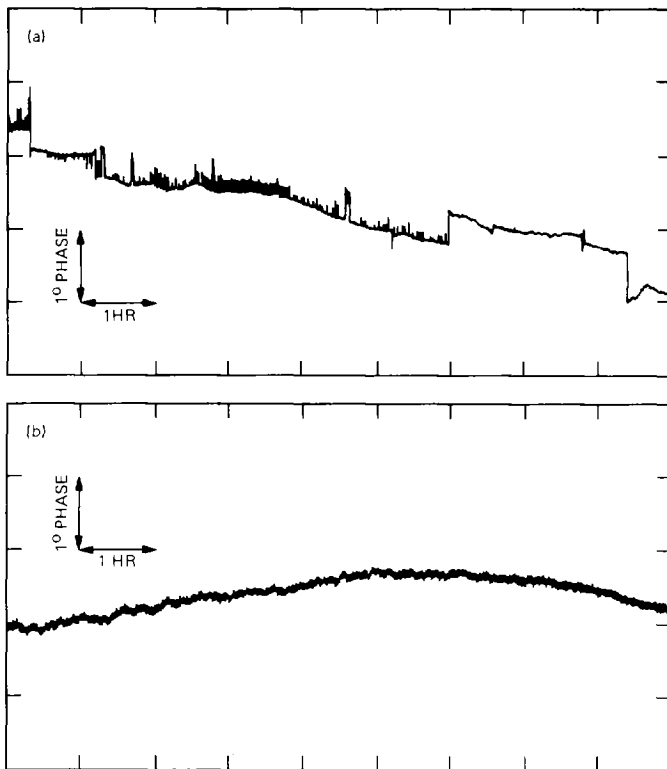

Fig. 5. Phase measured across a fiber-optic link which was installed through an antenna wrap-up such that the cable was flexed when the antenna moved: (a) without an optical isolator after the laser transmitter, (b) with an optical isolator after the laser transmitter.

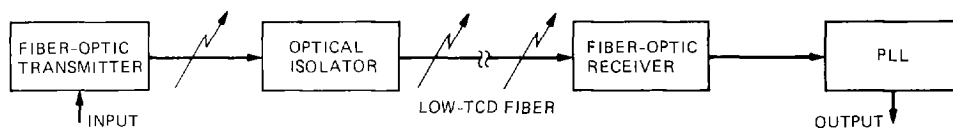

Fig. 7. A block diagram of a stable fiber-optic frequency reference distribution link.

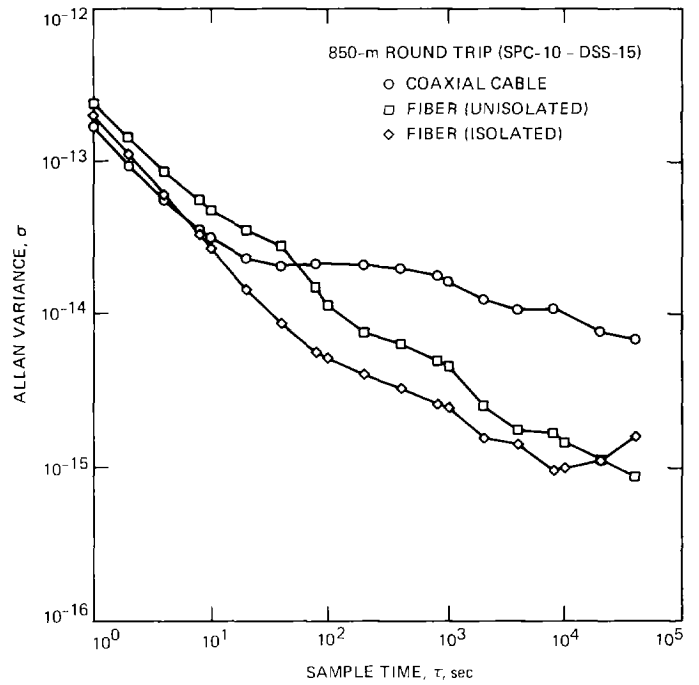

Fig. 6. The Allan variance of the phase noise shown in Fig. 3 (with and without an optical isolator) and for a coaxial cable installed in a similar route.